

l. 6 biuro@sklepat...v.p

can-am®

QUADRY ŚREM

KT RACING TEAM AUTORYZOWANE CENTRUM BRP



ATV Product Spec Book

2025

Vehicle Specifications, Accessories and Parts

Cennik zawiera sugerowane ceny detaliczne brutto w walucie PLN. Ceny mogą ulec zmianie bez wcześniejszego uprzedzenia.
Cennik nie jest ofertą w rozumieniu prawa.

TABLE OF CONTENTS

ATV ACCESSORY COMPATIBILITY GUIDE	5
UNITS COMPARATIVE CHART	6
G2, G2L, G2S ACCESSORIES	15
G3, G3L ACCESSORIES	55
PARTS AND MAINTENANCE	86

CANAMOFFROAD.COM

© 2024 Bombardier Recreational Products Inc. (BRP). All rights reserved. ®, TM and the BRP logo are trademarks of BRP or its affiliates. In the USA, products are distributed by BRP US Inc. †All other trademarks are the property of their respective owners. BRP reserves the right to discontinue or change specifications, prices, designs, features, models or equipment without incurring obligation. Some models depicted may include optional equipment. Product performance may vary depending on weather, temperature, altitude, driving ability and driver/passenger weight. ATVs and SxSs can be hazardous to operate. Never exceed the ATV-SxS's passenger capacity. All adult model ATVs are meant to be used by drivers aged 16 and older. Carefully read the vehicle's operator's guide. Follow all instructional and safety material and observe applicable laws and regulations. ATVs and SxSs are for off-road use only; never ride on paved surfaces or public roads. For your safety, the operator and passenger(s) must wear a helmet, eye protection and applicable protective clothing. Always remember that riding, alcohol and drugs don't mix. Never engage in stunt driving. Avoid excessive speed and be particularly careful on difficult terrain. Always ride responsibly and safely. See your authorized BRP dealer for details and visit <https://can-am.brp.com>.

Cennik zawiera sugerowane ceny detaliczne brutto w walucie PLN. Ceny mogą ulec zmianie bez wcześniejszego uprzedzenia.
Cennik nie jest ofertą w rozumieniu prawa.

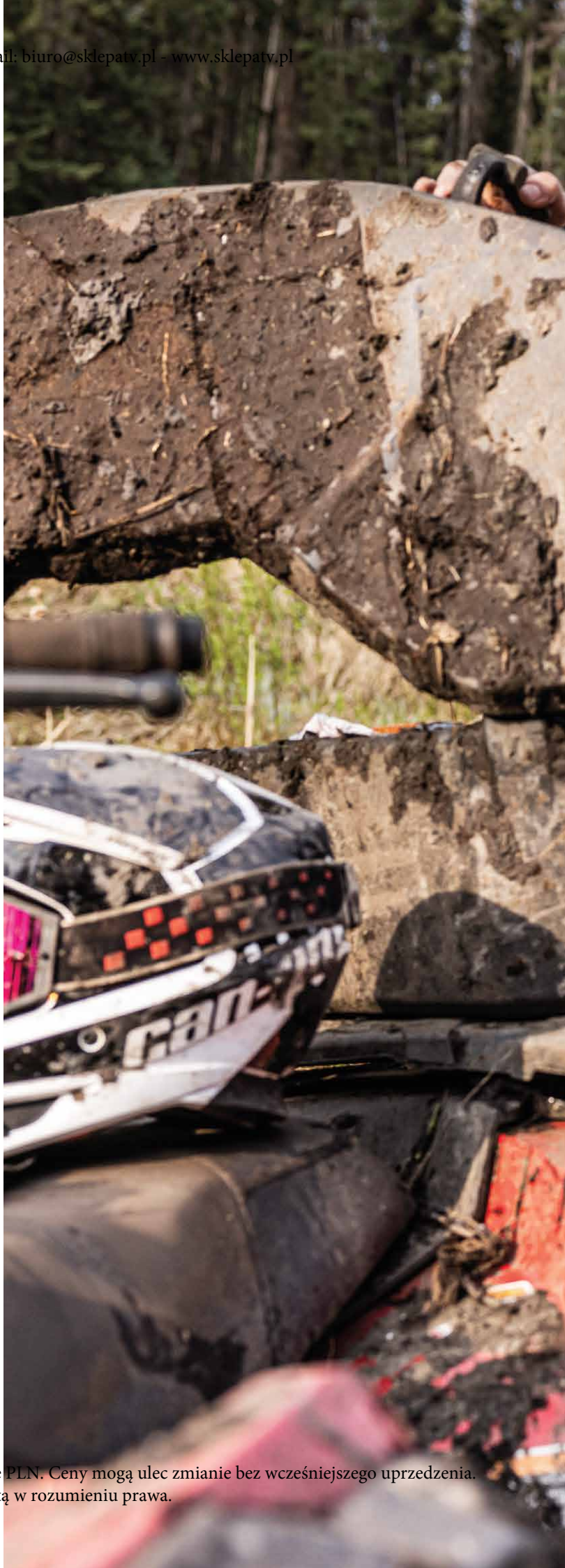



IF WE SELL IT, WE STAND BY IT.

BRP Limited Warranty* for new Parts, Accessories and Riding Gear

1-year limited warranty**

- Genuine BRP Parts and Accessories installed by you or your authorized BRP dealer
- Aftermarket Products sold through BRP
- Riding Gear

4-year limited warranty**

- Helmets

GET ALL THE DETAILS FROM
YOUR CAN-AM OFF-ROAD DEALER

* Purchased at an authorized BRP dealership/distributor or on a BRP-authorized online store. Other exclusions may apply; see complete limited warranty or contact your Can-Am Off-Road authorized dealer. This limited warranty does not apply to factory-installed accessories and Evinrude parts and accessories.

** Unless otherwise stipulated or required by law.

CUSTOMIZING MADE EASY

1

Select the model.

2

Select the package.

3

Customize color, engine, and accessories (or accessory bundles) for your vehicle.

4

Click "Save" or "Send to dealer."



If you can dream it, you can build it. And ride it. Creating a Can-Am vehicle tailor-made for our riders' needs has never been easier. Scan the QR code and follow the step-by-step above.

BUILD YOURS NOW

ATV ACCESSORY COMPATIBILITY GUIDE

We've made things super simple.

- Check your model year
- Choose engine and model
- Learn your **PLATFORM CODE**

This **PLATFORM CODE** will let you know at a glance if the accessory is compatible with your vehicle.

Model year	Model	Engine configuration	Platform code
2015	Outlander L	450, 500	G2L
	Outlander	500, 650, 800, 1000	G2
	Outlander L MAX	450, 500	G2L
	Outlander MAX	500, 650, 800, 1000	G2
	6x6	650, 1000	G2
	Renegade	500, 800, 1000	G2S
2016	Outlander L	450, 570	G2L
	Outlander	570, 650, 850, 1000	G2
	Outlander L MAX	450, 570	G2L
	Outlander MAX	570, 650, 850, 1000	G2
	6x6	650, 1000	G2
	Renegade	570, 850, 1000	G2S
2017	Outlander	450, 570	G2L
2018	Outlander	650, 850, 1000	G2
	Outlander MAX	450, 570	G2L
	Outlander MAX	650, 850, 1000	G2
	6x6	650, 1000	G2
	Renegade	570, 850, 1000	G2S
	2019	Outlander	450, 570
2020	Outlander	650, 850, 1000R	G2
	Outlander MAX	450, 570	G2L
2021	Outlander MAX	500, 700	G3L
2022	Outlander MAX	650, 850, 1000R	G2
2023	Outlander	500, 700	G3L
2024	Outlander	850, 1000R	G3
	Outlander PRO	HD5, HD7	G3L
2025	Outlander PRO MAX	HD7	G3L
	6x6	450	G2L
	6x6	650, 1000	G2
	Renegade	570, 650, 850, 1000R	G2S



G2L 6x6



G2 6x6



G3



G2L



G2S



G3L

Cennik zawiera sugerowane ceny detaliczne brutto w walucie PLN. Ceny mogą ulec zmianie bez wcześniejszego uprzedzenia.
Cennik nie jest ofertą w rozumieniu prawa.



OUTLANDER PRO HD5

OUTLANDER PRO HD5 T

OUTLANDER PRO XU HD5 T

OUTLANDER PRO XU HD7 T

OUTLANDER PRO XU HD7 T ABS

OUTLANDER MAX PRO XU HD7 T

Desert Tan

Desert Tan

Compass Green

Compass Green

Compass Green

Compass Green

	Desert Tan	Desert Tan	Compass Green	Compass Green	Compass Green	Compass Green		
ENGINES	Type	40 hp / 37 lb-ft, Rotax® ACE (Advanced Combustion Efficiency) 650 cc, single cylinder, liquid cooled	40 hp / 37 lb-ft, Rotax® ACE (Advanced Combustion Efficiency) 650 cc, single cylinder, liquid cooled	40 hp / 37 lb-ft, Rotax® ACE (Advanced Combustion Efficiency) 650 cc, single cylinder, liquid cooled	50 hp / 41 lb-ft, Rotax® ACE (Advanced Combustion Efficiency) 650 cc, single cylinder, liquid cooled	50 hp / 41 lb-ft, Rotax® ACE (Advanced Combustion Efficiency) 650 cc, single cylinder, liquid cooled	50 hp / 41 lb-ft, Rotax® ACE (Advanced Combustion Efficiency) 650 cc, single cylinder, liquid cooled	
	Fuel Delivery System	Intelligent Throttle Control (ITC™) with Electronic Fuel Injection (EFI)	Intelligent Throttle Control (ITC™) with Electronic Fuel Injection (EFI)	Intelligent Throttle Control (ITC™) with Electronic Fuel Injection (EFI)	Intelligent Throttle Control (ITC™) with Electronic Fuel Injection (EFI)	Intelligent Throttle Control (ITC™) with Electronic Fuel Injection (EFI)	Intelligent Throttle Control (ITC™) with Electronic Fuel Injection (EFI)	
	Transmission	pDrive primary CVT with work calibration Extra low L / H / N / R / P	pDrive primary CVT with work calibration Extra low L / H / N / R / P	pDrive primary CVT with work calibration Extra low L / H / N / R / P	pDrive primary CVT with work calibration Extra low L / H / N / R / P	pDrive primary CVT with work calibration Extra low L / H / N / R / P	pDrive primary CVT with work calibration Extra low L / H / N / R / P	
	Drive Train	Selectable 2WD / 4WD with Visco-Lok† auto-locking front differential	Selectable 2WD / 4WD with Visco-Lok† auto-locking front differential	Selectable 2WD / 4WD / Lock 4WD with Visco-4Lok front differential	Selectable 2WD / 4WD / Lock 4WD with Visco-4Lok front differential	Selectable 2WD / 4WD / Lock 4WD with BTC (Brake traction Control)	Selectable 2WD / 4WD / Lock 4WD with Visco-4Lok front differential	
	Driving assistance	Speed limiter	Speed limiter	Intelligent Engine Braking (iEB™) Speed limiter	Work / Standard / Sport modes Intelligent Engine Braking (iEB™) Speed limiter	Work / Standard / Sport modes Intelligent Engine Braking (iEB™) Speed limiter	Work / Standard / Sport modes Intelligent Engine Braking (iEB™) Speed limiter	
	Power Steering	N/A	N/A	Tri-Mode Dynamic Power Steering (DPS)	Tri-Mode Dynamic Power Steering (DPS)	Tri-Mode Dynamic Power Steering (DPS)	Tri-Mode Dynamic Power Steering (DPS)	
SUSPENSIONS	Front Suspension	Double A-arm 9.75 in. (24.8 cm) travel	Double A-arm 9.75 in. (24.8 cm) travel	Double A-arm 9.75 in. (24.8 cm) travel	Double A-arm 9.75 in. (24.8 cm) travel	Double A-arm 9.75 in. (24.8 cm) travel	Double A-arm 9.75 in. (24.8 cm) travel	
	Front Shocks	Twin tube	Twin tube	Twin tube	Twin tube	Twin tube	Twin tube	
	Rear Suspension	Double A-arm 10.25 in. (26 cm) travel	Double A-arm 10.25 in. (26 cm) travel	Double A-arm 10.25 in. (26 cm) travel	Double A-arm 10.25 in. (26 cm) travel	Double A-arm 10.25 in. (26 cm) travel	Double A-arm 10.25 in. (26 cm) travel	
	Rear Shocks	Twin tube	Twin tube	Twin tube	Twin tube	Twin tube	Twin tube	
TIRES / WHEELS	Front & Rear Tires	6-ply rating 26 x 8/10 x 12 in.	6-ply rating 26 x 8/10 x 12 in.	XPS Trail King, 6-ply rating, 26 x 8/10 x 12 in.	XPS Trail King, 6-ply rating, 26 x 8/10 x 12 in.	XPS Trail King, 6-ply rating, 26 x 8/10 x 12 in.	XPS Trail King, 6-ply rating, 26 x 8/10 x 12 in.	
	Wheels	12 in. Steel	12 in. Steel	12 in. cast aluminum	12 in. cast aluminum	12 in. cast aluminum	12 in. cast aluminum	
BRAKES	Front	Dual 214 mm disc brakes with hydraulic twin-piston calipers	Dual 214 mm disc brakes with hydraulic twin-piston calipers	Dual 214 mm disc brakes with hydraulic twin-piston calipers	Dual 214 mm disc brakes with hydraulic twin-piston calipers	Dual 214 mm disc brakes with hydraulic twin-piston calipers	Dual 214 mm disc brakes with hydraulic twin-piston calipers	
	Rear	Single 214 mm disc brake with hydraulic twin-piston caliper	Single 214 mm disc brake with hydraulic twin-piston caliper	Single 214 mm disc brake with hydraulic twin-piston caliper	Single 214 mm disc brake with hydraulic twin-piston caliper	Single 214 mm disc brake with hydraulic twin-piston caliper	Single 214 mm disc brake with hydraulic twin-piston caliper	
DIMENSIONS / CAPACITIES	Estimated Dry Weight *	800 lb (362.9 kg)	800 lb (362.9 kg)	883 lb (400.5 kg)	883 lb (400.5 kg)	883 lb (400.5 kg)	851 lb (386 kg)	
	L x W x H (includes mirrors)	89.9 x 48.8 x 48.2 in. (228.4 x 123.9 x 122.5 cm)	89.9 x 48.8 x 57.4 in. (228.4 x 123.9 x 145.6 cm)	89.9 x 48.8 x 57.4 in. (228.4 x 123.9 x 145.6 cm)	89.9 x 48.8 x 57.4 in. (228.4 x 123.9 x 145.6 cm)	89.9 x 48.8 x 57.4 in. (228.4 x 123.9 x 145.6 cm)	89.9 x 48.8 x 57.4 in. (228.4 x 123.9 x 145.6 cm)	94.2 x 47.6 x 54 in. (239.2 x 120.9 x 137.1 cm)
	Wheelbase	53 in. (134.5 cm)	53 in. (134.5 cm)	53 in. (134.5 cm)	53 in. (134.5 cm)	53 in. (134.5 cm)	53 in. (134.5 cm)	60.4 in. (153.5 cm)
	Ground Clearance	13 in. (33 cm)	13 in. (33 cm)	13 in. (33 cm)	13 in. (33 cm)	13 in. (33 cm)	13 in. (33 cm)	13 in. (33 cm)
	Seat Height	38.6 in. (98 cm)	38.6 in. (98 cm)	38.6 in. (98 cm)	38.6 in. (98 cm)	38.6 in. (98 cm)	38.6 in. (98 cm)	38.6 in. (98 cm)
	Rack Capacity	Front: 120 lb (54.4 kg) / Rear: 240 lb (109 kg)	Front: 120 lb (54.4 kg) / Rear: 240 lb (109 kg)	Front: 120 lb (54.4 kg) / Rear: 240 lb (109 kg)	Front: 120 lb (54.4 kg) / Rear: 240 lb (109 kg)	Front: 120 lb (54.4 kg) / Rear: 240 lb (109 kg)	Front: 120 lb (54.4 kg) / Rear: 240 lb (109 kg)	Front: 120 lb (54.4 kg) / Rear: 240 lb (109 kg)
	Storage Capacity	9 gal (34 L)	9 gal (34 L)	9 gal (34 L)	9 gal (34 L)	9 gal (34 L)	9 gal (34 L)	9 gal (34 L)
	Towing Capacity	1,830 lb (830 kg)	1,830 lb (830 kg) trailer with brakes / 870 lb (394 kg) trailer without brakes	1,830 lb (830 kg) trailer with brakes / 870 lb (394 kg) trailer without brakes	1,830 lb (830 kg) trailer with brakes / 870 lb (394 kg) trailer without brakes	1,830 lb (830 kg) trailer with brakes / 870 lb (394 kg) trailer without brakes	1,830 lb (830 kg) trailer with brakes / 870 lb (394 kg) trailer without brakes	1,830 lb (830 kg) trailer with brakes / 870 lb (394 kg) trailer without brakes
Fuel Capacity	5.1 gal (19.5 L)	5.1 gal (19.5 L)	5.1 gal (19.5 L)	5.1 gal (19.5 L)	5.1 gal (19.5 L)	5.1 gal (19.5 L)	5.1 gal (19.5 L)	
FEATURES	Gauge	4.5 in. Digital Display	4.5 in. Digital Display	4.5 in. Digital Display	4.5 in. Digital Display	4.5 in. Digital Display	4.5 in. Digital Display	
	Instrumentation	N/A	N/A	USB Phone charger	USB Phone charger	USB Phone charger	USB Phone charger	
	Ignition	RF Digitally Encoded Security System (D.E.S.S.™)	RF Digitally Encoded Security System (D.E.S.S.™)	RF Digitally Encoded Security System (D.E.S.S.™)	RF Digitally Encoded Security System (D.E.S.S.™)	RF Digitally Encoded Security System (D.E.S.S.™)	RF Digitally Encoded Security System (D.E.S.S.™)	
	Lighting	LED headlights and tail lights	LED headlights and tail lights LED signature	LED headlights and tail lights LED signature	LED headlights and tail lights LED signature	LED headlights and tail lights LED signature	LED headlights and tail lights LED signature	
	Winch	N/A	N/A	3,500 lb (1,588 kg) winch	3,500 lb (1,588 kg) winch	3,500 lb (1,588 kg) winch	3,500 lb (1,588 kg) winch	
	Seat	Standard	Standard	Standard	Standard	Standard	Standard	
	Handlebar	Standard	Standard	Standard	Standard	Standard	Standard	
Protection	Premium front bumper, rear bumper, full skid plate	Premium front bumper, rear bumper, full skid plate	Premium front bumper, rear bumper, full skid plate	Premium front bumper, rear bumper, full skid plate	Premium front bumper, rear bumper, full skid plate	Premium front bumper, rear bumper, full skid plate	Premium front bumper, rear bumper, full skid plate	

Cennik zawiera sugerowane ceny detaliczne brutto w walucie PLN. Ceny mogą ulec zmianie bez wcześniejszego uprzedzenia.

Cennik nie jest ofertą w rozumieniu prawa.



OUTLANDER DPS 500 T ABS	OUTLANDER MAX DPS 500 T ABS	OUTLANDER DPS 700 T ABS	OUTLANDER MAX DPS 700	OUTLANDER MAX DPS 700 T ABS	OUTLANDER X MR 700	OUTLANDER MAX XT 700	OUTLANDER MAX XT 700 T ABS
■ Granite Grey	■ Granite Grey	■ Legion Red	■ Legion Red	■ Legion Red	■ Legion Red	■ Platinum Satin	■ Platinum Satin

	OUTLANDER DPS 500 T ABS	OUTLANDER MAX DPS 500 T ABS	OUTLANDER DPS 700 T ABS	OUTLANDER MAX DPS 700	OUTLANDER MAX DPS 700 T ABS	OUTLANDER X MR 700	OUTLANDER MAX XT 700	OUTLANDER MAX XT 700 T ABS	
ENGINES	Type	40 hp / 37 lb-ft, Rotax® ACE (Advanced Combustion Efficiency) 650 cc, single cylinder, liquid cooled	40 hp / 37 lb-ft, Rotax® ACE (Advanced Combustion Efficiency) 650 cc, single cylinder, liquid cooled	50 hp / 41 lb-ft, Rotax® ACE (Advanced Combustion Efficiency) 650 cc, single cylinder, liquid cooled	50 hp / 41 lb-ft, Rotax® ACE (Advanced Combustion Efficiency) 650 cc, single cylinder, liquid cooled	50 hp / 41 lb-ft, Rotax® ACE (Advanced Combustion Efficiency) 650 cc, single cylinder, liquid cooled	50 hp / 41 lb-ft, Rotax® ACE (Advanced Combustion Efficiency) 650 cc, single cylinder, liquid cooled with strategically positioned engine air intake	50 hp / 41 lb-ft, Rotax® ACE (Advanced Combustion Efficiency) 650 cc, single cylinder, liquid cooled	
	Fuel Delivery System	Intelligent Throttle Control (iTC™) with Electronic Fuel Injection (EFI)	Intelligent Throttle Control (iTC™) with Electronic Fuel Injection (EFI)	Intelligent Throttle Control (iTC™) with Electronic Fuel Injection (EFI)	Intelligent Throttle Control (iTC™) with Electronic Fuel Injection (EFI)	Intelligent Throttle Control (iTC™) with Electronic Fuel Injection (EFI)	Intelligent Throttle Control (iTC™) with Electronic Fuel Injection (EFI)	Intelligent Throttle Control (iTC™) with Electronic Fuel Injection (EFI)	
	Transmission	pDrive primary CVT L / H / N / R / P	pDrive primary CVT L / H / N / R / P	pDrive primary CVT L / H / N / R / P	pDrive primary CVT L / H / N / R / P	pDrive primary CVT L / H / N / R / P	pDrive primary CVT with strategically positioned air intake and exhaust Extra low L / H / N / R / P	pDrive primary CVT L / H / N / R / P	pDrive primary CVT L / H / N / R / P
	Drive Train	Selectable 2WD / 4WD with BTC (Brake traction Control)	Selectable 2WD / 4WD with BTC (Brake traction Control)	Selectable 2WD / 4WD with BTC (Brake traction Control)	Selectable 2WD / 4WD with Visco-Lok† QE auto-locking front differential	Selectable 2WD / 4WD with BTC (Brake traction Control)	Selectable 2WD / 4WD / Lock 4WD with Visco-4Lok front differential	Selectable 2WD / 4WD with Visco-Lok† QE auto-locking front differential	Selectable 2WD / 4WD with BTC (Brake traction Control)
	Driving assistance	N/A	NA	Work / Standard / Sport modes	Work / Standard / Sport modes	Work / Standard / Sport modes	Work / Standard / Sport modes	Work / Standard / Sport modes Intelligent Engine Braking (iEB™)	Work / Standard / Sport modes Intelligent Engine Braking (iEB™)
	Power Steering	Tri-Mode Dynamic Power Steering (DPS)	Tri-Mode Dynamic Power Steering (DPS)	Tri-Mode Dynamic Power Steering (DPS)	Tri-Mode Dynamic Power Steering (DPS)	Tri-Mode Dynamic Power Steering (DPS)	Tri-Mode Dynamic Power Steering (DPS)	Tri-Mode Dynamic Power Steering (DPS)	Tri-Mode Dynamic Power Steering (DPS)
SUSPENSIONS	Front Suspension	Double A-arm 9.75 in. (24.8 cm) travel	Double A-arm 9.75 in. (24.8 cm) travel	Double A-arm 9.75 in. (24.8 cm) travel	Double A-arm 9.75 in. (24.8 cm) travel	Double A-arm 9.75 in. (24.8 cm) travel	Double A-arm 9 in. (22.9 cm) travel	Double A-arm 9.75 in. (24.8 cm) travel	
	Front Shocks	Twin tube	Twin tube	Twin tube	Twin tube	Twin tube	Twin tube	Twin tube	
	Rear Suspension	Double A-arm 10.25 in. (26 cm) travel	Double A-arm 10.25 in. (26 cm) travel	Double A-arm 10.25 in. (26 cm) travel	Double A-arm 10.25 in. (26 cm) travel	Double A-arm 10.25 in. (26 cm) travel	Double A-arm 9.75 in. (24.8 cm) travel	Double A-arm 10.25 in. (26 cm) travel	
	Rear Shocks	Twin tube	Twin tube	Twin tube	Twin tube	Twin tube	Twin tube	Twin tube	
TIRES / WHEELS	Front & Rear Tires	25 x 8/10 x 12 in.	25 x 8/10 x 12 in.	25 x 8/10 x 12 in.	25 x 8/10 x 12 in.	25 x 8/10 x 12 in.	XPS Swamp King 28 x 8/10 x 14 in.	XPS Trail Force 26 x 8/10 x 14 in.	
	Wheels	12 in. cast aluminum	12 in. cast aluminum	12 in. cast aluminum	12 in. cast aluminum	12 in. cast aluminum	14 in. Aluminum	14 in. Aluminum	
BRAKES	Front	Dual 214 mm disc brakes with hydraulic twin-piston calipers	Dual 214 mm disc brakes with hydraulic twin-piston calipers	Dual 214 mm disc brakes with hydraulic twin-piston calipers	Dual 214 mm disc brakes with hydraulic twin-piston calipers	Dual 214 mm disc brakes with hydraulic twin-piston calipers	Dual 214 mm disc brakes with hydraulic twin-piston calipers	Dual 214 mm disc brakes with hydraulic twin-piston calipers	
	Rear	Single 214 mm disc brake with hydraulic twin-piston caliper	Single 214 mm disc brake with hydraulic twin-piston caliper	Single 214 mm disc brake with hydraulic twin-piston caliper	Single 214 mm disc brake with hydraulic twin-piston caliper	Single 214 mm disc brake with hydraulic twin-piston caliper	Single 214 mm disc brake with hydraulic twin-piston caliper	Single 214 mm disc brake with hydraulic twin-piston caliper	
DIMENSIONS / CAPACITIES	Estimated Dry Weight *	767.6 lb (348.2 kg)	802.6 lb (364.1 kg)	802.6 lb (364.1 kg)	785 lb (356.1 kg)	802.6 lb (364.1 kg)	876 lb (397.3 kg)	893 lb (405.1 kg)	
	L x W x H (includes mirrors)	86.7 x 47.6 x 56.9 in. (220.2 x 120.9 x 144.6 cm)	94.2 x 47.6 x 56.9 in. (239.2 x 120.9 x 144.6 cm)	94.2 x 47.6 x 56.9 in. (239.2 x 120.9 x 144.6 cm)	94.2 x 47.6 x 54 in. (239.2 x 120.9 x 137.1 cm)	94.2 x 47.6 x 56.9 in. (239.2 x 120.9 x 144.6 cm)	89.9 x 48.8 x 48.2 in. (228.4 x 123.9 x 122.5 cm)	94.2 x 47.6 x 54 in. (239.2 x 120.9 x 137.1 cm)	94.2 x 47.6 x 57.4 in. (239.2 x 120.9 x 145.6 cm)
	Wheelbase	53 in. (134.5 cm)	60.4 in. (153.5 cm)	60.4 in. (153.5 cm)	60.4 in. (153.5 cm)	60.4 in. (153.5 cm)	53 in. (134.5 cm)	60.4 in. (153.5 cm)	60.4 in. (153.5 cm)
	Ground Clearance	12 in. (30.5 cm)	12 in. (30.5 cm)	12 in. (30.5 cm)	12 in. (30.5 cm)	12 in. (30.5 cm)	13 in. (33 cm)	12.5 in. (31.8 cm)	12.5 in. (31.8 cm)
	Seat Height	38 in. (96.7 cm)	38.6 in. (98 cm)	38.6 in. (98 cm)	38.6 in. (98 cm)	38.6 in. (98 cm)	38.6 in. (98 cm)	38.6 in. (98 cm)	38.6 in. (98 cm)
	Rack Capacity	Front: 120 lb (54.4 kg) / Rear: 240 lb (109 kg)	Front: 120 lb (54.4 kg) / Rear: 240 lb (109 kg)	Front: 120 lb (54.4 kg) / Rear: 240 lb (109 kg)	Front: 120 lb (54.4 kg) / Rear: 240 lb (109 kg)	Front: 120 lb (54.4 kg) / Rear: 240 lb (109 kg)	Front: NA / Rear: 240 lb (109 kg)	Front: 120 lb (54.4 kg) / Rear: 240 lb (109 kg)	Front: 120 lb (54.4 kg) / Rear: 240 lb (109 kg)
	Storage Capacity	9 gal (34 L)	9 gal (34 L)	9 gal (34 L)	9 gal (34 L)	9 gal (34 L)	1 gal (3.8 L)	9 gal (34 L)	9 gal (34 L)
	Towing Capacity	1,830 lb (830 kg) trailer with brakes / 870 lb (394 kg) trailer without brakes	1,830 lb (830 kg) trailer with brakes / 870 lb (394 kg) trailer without brakes	1,830 lb (830 kg) trailer with brakes / 870 lb (394 kg) trailer without brakes	1,830 lb (830 kg)	1,830 lb (830 kg) trailer with brakes / 870 lb (394 kg) trailer without brakes	1,830 lb (830 kg)	1,830 lb (830 kg)	1,830 lb (830 kg) trailer with brakes / 870 lb (394 kg) trailer without brakes
Fuel Capacity	5.1 gal (19.5 L)	5.1 gal (19.5 L)	5.1 gal (19.5 L)	5.1 gal (19.5 L)	5.1 gal (19.5 L)	5.1 gal (19.5 L)	5.1 gal (19.5 L)	5.1 gal (19.5 L)	
FEATURES	Gauge	4.5 in. Digital Display	4.5 in. Digital Display	4.5 in. Digital Display	4.5 in. Digital Display	4.5 in. Digital Display	4.5 in. Digital Display	4.5 in. Digital Display	
	Instrumentation	N/A	N/A	N/A	N/A	N/A	USB Phone charger	USB Phone charger	
	Ignition	RF Digitally Encoded Security System (D.E.S.S.™)	RF Digitally Encoded Security System (D.E.S.S.™)	RF Digitally Encoded Security System (D.E.S.S.™)	RF Digitally Encoded Security System (D.E.S.S.™)	RF Digitally Encoded Security System (D.E.S.S.™)	RF Digitally Encoded Security System (D.E.S.S.™) with with cord	RF Digitally Encoded Security System (D.E.S.S.™)	RF Digitally Encoded Security System (D.E.S.S.™)
	Lighting	LED headlights and tail lights LED signature	LED headlights and tail lights LED signature	LED headlights and tail lights LED signature	LED headlights and tail lights	LED headlights and tail lights LED signature	LED headlights and tail lights	LED headlights and tail lights	LED headlights and tail lights LED signature
	Winch	N/A	N/A	N/A	N/A	N/A	N/A	3,500 lb (1,588 kg) winch	3,500 lb (1,588 kg) winch
	Seat	Standard	Standard	Standard	Standard	Standard	Standard	Standard	Standard
	Handlebar	Standard	Standard	Standard	Standard	Standard	Standard	Standard	Standard
Protection	Full skid plate	Full skid plate	Full skid plate	Full skid plate	Full skid plate	Front bumper, X mr plate	Front bumper, rear skid plate	Front bumper, rear skid plate	

Cennik zawiera sugerowane ceny detaliczne brutto w walucie PLN. Ceny mogą ulec zmianie bez wcześniejszego uprzedzenia.

Cennik nie jest ofertą w rozumieniu prawa.

**OUTLANDER XT 850 T ABS****OUTLANDER MAX XT 850****OUTLANDER MAX XT 850 T ABS****OUTLANDER MAX DPS 1000R****OUTLANDER MAX DPS 1000R T ABS****OUTLANDER X MR 1000R**

■ Fiery Red

■ Fiery Red

■ Fiery Red

■ Granite Grey

■ Granite Grey

■ Hyper Silver & Legion Red

	Fiery Red	Fiery Red	Fiery Red	Granite Grey	Granite Grey	Hyper Silver & Legion Red	
ENGINES	Type	82 hp / 66 lb-ft, Rotax 999 cc V-twin, DOHC, liquid cooled	82 hp / 66 lb-ft, Rotax 999 cc V-twin, DOHC, liquid cooled	82 hp / 66 lb-ft, Rotax 999 cc V-twin, DOHC, liquid cooled	101 hp / 69 lb-ft, Rotax 999 cc V-twin, DOHC, liquid cooled	101 hp / 69 lb-ft, Rotax 999 cc V-twin, DOHC, liquid cooled	101 hp / 69 lb-ft, Rotax 999 cc V-twin, DOHC, liquid cooled with strategically positioned engine air intake
	Fuel Delivery System	Intelligent Throttle Control (iTCT™) with Electronic Fuel Injection (EFI)	Intelligent Throttle Control (iTCT™) with Electronic Fuel Injection (EFI)	Intelligent Throttle Control (iTCT™) with Electronic Fuel Injection (EFI)	Intelligent Throttle Control (iTCT™) with Electronic Fuel Injection (EFI)	Intelligent Throttle Control (iTCT™) with Electronic Fuel Injection (EFI)	Intelligent Throttle Control (iTCT™) with Electronic Fuel Injection (EFI)
	Transmission	pDrive primary CVT L / H / N / R / P	pDrive primary CVT L / H / N / R / P	pDrive primary CVT L / H / N / R / P	pDrive primary CVT L / H / N / R / P	pDrive primary CVT L / H / N / R / P	pDrive primary CVT with strategically positioned air intake and exhaust Extra low L / H / N / R / P
	Drive Train	Selectable 2WD / 4WD with BTC (Brake traction Control)	Selectable 2WD / 4WD with Visco-Lok† QE auto-locking front differential	Selectable 2WD / 4WD with BTC (Brake traction Control)	Selectable 2WD / 4WD with Visco-Lok† QE auto-locking front differential	Selectable 2WD / 4WD with BTC (Brake traction Control)	Selectable 2WD / 4WD / Lock 4WD with Visco-4Lock front differential
	Driving assistance	Work / Standard / Sport modes Intelligent Engine Braking (iEB™)	Work / Standard / Sport modes Intelligent Engine Braking (iEB™)	Work / Standard / Sport modes Intelligent Engine Braking (iEB™)	Work / Standard / Sport modes Intelligent Engine Braking (iEB™)	Work / Standard / Sport modes Intelligent Engine Braking (iEB™)	Work / Standard / Sport modes Intelligent Engine Braking (iEB™)
	Power Steering	Tri-Mode Dynamic Power Steering (DPS)	Tri-Mode Dynamic Power Steering (DPS)	Tri-Mode Dynamic Power Steering (DPS)	Tri-Mode Dynamic Power Steering (DPS)	Tri-Mode Dynamic Power Steering (DPS)	Tri-Mode Dynamic Power Steering (DPS)
SUSPENSIONS	Front Suspension	Arched Double A-arm 10.75 in. (27.3 cm) travel	Arched Double A-arm 10.75 in. (27.3 cm) travel	Arched Double A-arm 10.75 in. (27.3 cm) travel	Arched Double A-arm 10.75 in. (27.3 cm) travel	Arched Double A-arm 10.75 in. (27.3 cm) travel	Arched Double A-arm 7.5 in. (19 cm) travel
	Front Shocks	Twin Tube	Twin Tube	Twin Tube	Twin Tube	Twin Tube	SHOWA Internal Floating Pistons (IFP) Shocks
	Rear Suspension	Arched Double A-arm 12 in. (30.5 cm) travel	Arched Double A-arm 12 in. (30.5 cm) travel	Arched Double A-arm 12 in. (30.5 cm) travel	Arched Double A-arm 12 in. (30.5 cm) travel	Arched Double A-arm 12 in. (30.5 cm) travel	Arched Double A-arm 10.2 in. (25.9 cm) travel
	Rear Shocks	Twin Tube	Twin Tube	Twin Tube	Twin Tube	Twin Tube	SHOWA Internal Floating Pistons (IFP) Shocks
TIRES / WHEELS	Front & Rear Tires	XPS Trail King 2 - 26 x 8/10 x 14	XPS Trail King 2 - 26 x 8/10 x 14	XPS Trail King 2 - 26 x 8/10 x 14	26 x 8/10 x 14 in.	26 x 8/10 x 14 in.	XPS Swamp King XL 30 in.
	Wheels	14 in. Aluminum	14 in. Aluminum	14 in. Aluminum	14 in. Aluminum	14 in. Aluminum	14 in. Aluminum
BRAKES	Front	Dual 214 mm disc brakes with hydraulic twin-piston calipers	Dual 214 mm disc brakes with hydraulic twin-piston calipers	Dual 214 mm disc brakes with hydraulic twin-piston calipers	Dual 214 mm disc brakes with hydraulic twin-piston calipers	Dual 214 mm disc brakes with hydraulic twin-piston calipers	Dual 214 mm disc brakes with hydraulic twin-piston calipers
	Rear	Single 214 mm disc brakes with hydraulic twin-piston calipers	Single 214 mm disc brakes with hydraulic twin-piston calipers	Single 214 mm disc brakes with hydraulic twin-piston calipers	Dual 214 mm disc brakes with hydraulic twin-piston calipers	Single 214 mm disc brake with hydraulic twin-piston caliper	Dual 214 mm disc brakes with hydraulic twin-piston calipers
DIMENSIONS / CAPACITIES	Estimated Dry Weight *	1,018 lb (463 kg)	1,023 lb (465 kg)	1,018 lb (463 kg)	992 lb (451 kg)	1,029 (468 kg)	1,071 lb (487 kg)
	L x W x H (includes mirrors)	91.9 x 48.5 x 49 in. (233.4 x 123.2 x 124.5 cm)	99 x 48.5 x 56.4 in. (252 x 123.2 x 143.2 cm)	91.9 x 48.5 x 49 in. (233.4 x 123.2 x 124.5 cm)	94.8 x 48.5 x 56.4 in. (240.8 x 123.2 x 143.2 cm)	99.7 x 48.5 x 56.4 in. (253.4 x 123.2 x 143.2 cm)	95.6 x 49.7 x 54.2 in. (242.9 x 126.2 x 137.6 cm)
	Wheelbase	52.8 in. (134.1 cm)	60.8 in. (154.4 cm)	52.8 in. (134.1 cm)	60.8 in. (154.4 cm)	60.8 in. (154.4 cm)	52.8 in. (134.2 cm)
	Ground Clearance	12 in. (30.5 cm)	12 in. (30.5 cm)	12 in. (30.5 cm)	Seat Height	12 in. (30.5 cm)	13 in. (33 cm)
	Seat Height	37.8 in. (96 cm)	37.8 in. (96 cm)	37.8 in. (96 cm)	Rack Capacity	37.8 in. (96 cm)	37.8 in. (96 cm)
	Rack Capacity	Front: 120 lb (54.4 kg) / Rear: 240 lb (109 kg)	Front: 120 lb (54.4 kg) / Rear: 240 lb (109 kg)	Front: 120 lb (54.4 kg) / Rear: 240 lb (109 kg)	Front: 120 lb (54.4 kg) / Rear: 240 lb (109 kg)	Front: 120 lb (54.4 kg) / Rear: 240 lb (109 kg)	Front: 120 lb (54.4 kg) / Rear: 240 lb (109 kg)
	Storage Capacity	10.6 gal (40 L)	10.6 gal (40 L)	10.6 gal (40 L)	10.6 gal (40 L)	10.6 gal (40 L)	1 gal (3.8 L)
	Towing Capacity	1,830 lb (830 kg)	1,830 lb (830 kg)	1,830 lb (830 kg)	1,830 lb (830 kg)	1,830 lb (830 kg)	1,830 lb (830 kg)
Fuel Capacity	5.1 gal (19.5 L)	5.1 gal (19.5 L)	5.1 gal (19.5 L)	5.1 gal (19.5 L)	5.1 gal (19.5 L)	5.1 gal (19.5 L)	
FEATURES	Gauge	7.6 in. wide digital display	7.6 in. wide digital display	7.6 in. wide digital display	7.6 in. wide digital display	7.6 in. wide digital display	7.6 in. wide digital display
	Instrumentation	Phone storage & USB charger	Phone storage & USB charger	Phone storage & USB charger	Phone Storage	Phone Storage	Phone storage & USB charger
	Ignition	RF Digitally Encoded Security System (D.E.S.S.™)	RF Digitally Encoded Security System (D.E.S.S.™)	RF Digitally Encoded Security System (D.E.S.S.™)	RF Digitally Encoded Security System (D.E.S.S.™)	RF Digitally Encoded Security System (D.E.S.S.™)	RF Digitally Encoded Security System (D.E.S.S.™)
	Lighting	LED headlights and tail lights	LED headlights and tail lights	LED headlights and tail lights	LED headlights and tail lights LED signature	LED headlights and tail lights LED signature	LED headlights and tail lights LED signature
	Winch	3,500 lb (1,588 kg) winch	3,500 lb (1,588 kg) winch	3,500 lb (1,588 kg) winch	NA	NA	3,500 lb (1,588 kg) bumper mounted winch with synthetic rope
	Seat	Standard	Standard	Standard	Standard	Standard	Special Edition seat (color, stitching and material)
	Handlebar	Standard	Standard	Standard	Standard	Standard	Aluminum tapered-profile handlebar with J-hook and 1 in. riser
Protection	Full skid plate, front bumper, rear bumper	Full skid plate, front bumper, rear bumper	Full skid plate, front bumper, rear bumper	Full skid plate	Full skid plate	Full skid plate, front mud bumper with winch mount, rear bumper	

Cennik zawiera sugerowane ceny detaliczne brutto w walucie PLN. Ceny mogą ulec zmianie bez wcześniejszego uprzedzenia.

Cennik nie jest ofertą w rozumieniu prawa.



Quality team - tel. 61 28 35 657 - email: biuro@sklady.pl - www.yamaha.pl

OUTLANDER XT-P 1000R

OUTLANDER MAX XT-P 1000R

OUTLANDER XT-P 1000R T ABS

OUTLANDER MAX XT-P 1000R T ABS

OUTLANDER MAX LIMITED 1000R

OUTLANDER MAX LIMITED 1000R T ABS

OUTLANDER MAX PRO XU HD8 T

OUTLANDER MAX PRO XU HD10 T

Mineral Grey & Orange Crush

Mineral Grey & Orange Crush

Mineral Grey & Orange Crush

Mineral Grey & Orange Crush

Dusty Navy

Dusty Navy

Granite Grey

Platinum Satin

		OUTLANDER XT-P 1000R	OUTLANDER MAX XT-P 1000R	OUTLANDER XT-P 1000R T ABS	OUTLANDER MAX XT-P 1000R T ABS	OUTLANDER MAX LIMITED 1000R	OUTLANDER MAX LIMITED 1000R T ABS	OUTLANDER MAX PRO XU HD8 T	OUTLANDER MAX PRO XU HD10 T
ENGINES	Type	101 hp / 69 lb-ft, Rotax 999 cc V-twin, DOHC, liquid cooled	101 hp / 69 lb-ft, Rotax 999 cc V-twin, DOHC, liquid cooled	101 hp / 69 lb-ft, Rotax 999 cc V-twin, DOHC, liquid cooled	101 hp / 69 lb-ft, Rotax 999 cc V-twin, DOHC, liquid cooled	101 hp / 69 lb-ft, Rotax 999 cc V-twin, DOHC, liquid cooled	101 hp / 69 lb-ft, Rotax 999 cc V-twin, DOHC, liquid cooled	82 hp / 66 lb-ft, Rotax 999 cc V-twin, DOHC, liquid cooled	101 hp / 69 lb-ft, Rotax 999 cc V-twin, DOHC, liquid cooled
	Fuel Delivery System	Intelligent Throttle Control (iTC™) with Electronic Fuel Injection (EFI)	Intelligent Throttle Control (iTC™) with Electronic Fuel Injection (EFI)	Intelligent Throttle Control (iTC™) with Electronic Fuel Injection (EFI)	Intelligent Throttle Control (iTC™) with Electronic Fuel Injection (EFI)	Intelligent Throttle Control (iTC™) with Electronic Fuel Injection (EFI)	Intelligent Throttle Control (iTC™) with Electronic Fuel Injection (EFI)	Intelligent Throttle Control (iTC™) with Electronic Fuel Injection (EFI)	Intelligent Throttle Control (iTC™) with Electronic Fuel Injection (EFI)
	Transmission	pDrive primary CVT L / H / N / R / P	pDrive primary CVT L / H / N / R / P	pDrive primary CVT L / H / N / R / P	pDrive primary CVT L / H / N / R / P	pDrive primary CVT L / H / N / R / P	pDrive primary CVT L / H / N / R / P	pDrive primary CVT with work calibration Extra low L / H / N / R / P	pDrive primary CVT with work calibration Extra low L / H / N / R / P
	Drive Train	Selectable 2WD / 4WD / Lock 4WD with Visco-4Lok front differential	Selectable 2WD / 4WD / Lock 4WD with Visco-4Lok front differential	Selectable 2WD / 4WD / Lock 4WD with BTC (Brake traction Control)	Selectable 2WD / 4WD / Lock 4WD with BTC (Brake traction Control)	Selectable 2WD / 4WD / Lock 4WD with Visco-4Lok front differential	Selectable 2WD / 4WD / Lock 4WD with BTC (Brake traction Control)	Selectable 2WD / 4WD / Lock 4WD with Visco-4Lok front differential	Selectable 2WD / 4WD / Lock 4WD with Visco-4Lok front differential
	Driving assistance	Work / Standard / Sport modes Intelligent Engine Braking (iEB™)	Work / Standard / Sport modes Intelligent Engine Braking (iEB™)	Work / Standard / Sport modes Intelligent Engine Braking (iEB™)	Work / Standard / Sport modes Intelligent Engine Braking (iEB™)	Work / Standard / Sport modes Intelligent Engine Braking (iEB™)	Work / Standard / Sport modes Intelligent Engine Braking (iEB™)	Work / Standard / Sport modes Intelligent Engine Braking (iEB™) Speed limiter	Work / Standard / Sport modes Intelligent Engine Braking (iEB™) Speed limiter
	Power Steering	Tri-Mode Dynamic Power Steering (DPS)	Tri-Mode Dynamic Power Steering (DPS)	Tri-Mode Dynamic Power Steering (DPS)	Tri-Mode Dynamic Power Steering (DPS)	Tri-Mode Dynamic Power Steering (DPS)	Tri-Mode Dynamic Power Steering (DPS)	Tri-Mode Dynamic Power Steering (DPS)	Tri-Mode Dynamic Power Steering (DPS)
SUSPENSIONS	Front Suspension	Arched Double A-arm with sway bar 10.75 in. (27.3 cm) travel	Arched Double A-arm with sway bar 10.8 in. (27.4 cm) travel	Arched Double A-arm with sway bar 10.8 in. (27.4 cm) travel	Arched Double A-arm with sway bar 10.8 in. (27.4 cm) travel	Arched Double A-arm with sway bar 10.8 in. (27.4 cm) travel	Arched Double A-arm with sway bar 10.8 in. (27.4 cm) travel	Arched Double A-arm with sway bar 10.8 in. (27.4 cm) travel	Arched Double A-arm with sway bar 10.8 in. (27.4 cm) travel
	Front Shocks	FOX† 1.5 PODIUM† QS3	FOX Piggyback Gas Shocks	FOX Piggyback Gas Shocks	FOX Piggyback Gas Shocks	FOX Piggyback Gas Shocks	FOX Piggyback Gas Shocks	Twin tube	Twin tube
	Rear Suspension	Arched Double A-arm 12 in. (30.5 cm) travel	Arched Double A-arm 12 in. (30.5 cm) travel	Arched Double A-arm 12 in. (30.5 cm) travel	Arched Double A-arm 12 in. (30.5 cm) travel	Arched Double A-arm 12 in. (30.5 cm) travel	Arched Double A-arm 12 in. (30.5 cm) travel	Arched Double A-arm 12 in. (30.5 cm) travel	Arched Double A-arm 12 in. (30.5 cm) travel
	Rear Shocks	FOX† 1.5 PODIUM† QS3	FOX Piggyback Gas Shocks	FOX Piggyback Gas Shocks	FOX Piggyback Gas Shocks	FOX Piggyback Gas Shocks	FOX Piggyback Gas Shocks	Twin tube	Twin tube
TIRES / WHEELS	Front & Rear Tires	XPS Trail King 2 - 27 x 8/10 x 14	XPS Trail King 2 - 27 x 8/10 x 14	XPS Trail King 2 - 27 x 8/10 x 14	XPS Trail King 2 - 27 x 8/10 x 14	XPS Trail King 2 - 27 x 8/10 x 14	XPS Trail King 2 - 27 x 8/10 x 14	XPS Trail King - 27 x 8/10 x 14	XPS Trail King - 27 x 8/10 x 14
	Wheels	14 in. Aluminum Beadlock	14 in. Aluminum Beadlock	14 in. Aluminum Beadlock	14 in. Aluminum Beadlock	14 in. Aluminum Beadlock	14 in. Aluminum Beadlock	14 in. Aluminum Beadlock	14 in. Aluminum Beadlock
BRAKES	Front	Dual 214 mm disc brakes with hydraulic twin-piston calipers	Dual 214 mm disc brakes with hydraulic twin-piston calipers	Dual 214 mm disc brakes with hydraulic twin-piston calipers	Dual 214 mm disc brakes with hydraulic twin-piston calipers	Dual 214 mm disc brakes with hydraulic twin-piston calipers	Dual 214 mm disc brakes with hydraulic twin-piston calipers	Dual 214 mm disc brakes with hydraulic twin-piston calipers	Dual 214 mm disc brakes with hydraulic twin-piston calipers
	Rear	Dual 214 mm disc brakes with hydraulic twin-piston calipers	Dual 214 mm disc brakes with hydraulic twin-piston calipers	Single 214 mm disc brake with hydraulic twin-piston caliper	Single 214 mm disc brake with hydraulic twin-piston caliper	Dual 214 mm disc brakes with hydraulic twin-piston calipers	Single 214 mm disc brake with hydraulic twin-piston caliper	Single 214 mm disc brake with hydraulic twin-piston caliper	Single 214 mm disc brake with hydraulic twin-piston caliper
DIMENSIONS / CAPACITIES	Estimated Dry Weight *	1,000 lb (455 kg)	1,000 lb (455 kg)	1,038 lb (472 kg)	1,063 lb (483 kg)	1,072 lb (487 kg)	1,110 (505 kg)	1,078 lb (490 kg)	1,078 lb (490 kg)
	L x W x H (includes mirrors)	88.4 x 48.5 x 49 in. (224.6 x 123.1 x 124.5 cm)	88.4 x 48.5 x 49 in. (224.6 x 123.1 x 124.5 cm)	91.9 x 48.5 x 49 in. (233.4 x 123.2 x 124.5 cm)	102.6 x 48.5 x 56.4 in. (260.6 x 123.2 x 143.3 cm)	99 x 48.5 x 56.4 in. (252 x 123.2 x 143.2 cm)	102.6 x 48.5 x 56.4 in. (260.6 x 123.2 x 143.2 cm)	99 x 48.5 x 56.4 in. (252 x 123.2 x 143.2 cm)	99 x 48.5 x 56.4 in. (252 x 123.2 x 143.2 cm)
	Wheelbase	52.8 in. (134.2 cm)	52.8 in. (134.2 cm)	52.8 in. (134.1 cm)	60.8 in. (154.4 cm)	60.8 in. (154.4 cm)	60.8 in. (154.4 cm)	60.8 in. (154.4 cm)	60.8 in. (154.4 cm)
	Ground Clearance	12 in. (30.5 cm)	12 in. (30.5 cm)	12 in. (30.5 cm)	12 in. (30.5 cm)	12 in. (30.5 cm)	12 in. (30.5 cm)	12.5 in. (31.75 cm)	12.5 in. (31.75 cm)
	Seat Height	37.8 in. (96 cm)	37.8 in. (96 cm)	37.8 in. (96 cm)	37.8 in. (96 cm)	37.8 in. (96 cm)	37.8 in. (96 cm)	38.3 in. (97.3 cm)	38.3 in. (97.3 cm)
	Rack Capacity	Front: 120 lb (54.4 kg) / Rear: 240 lb (109 kg)	Front: 120 lb (54.4 kg) / Rear: 240 lb (109 kg)	Front: 120 lb (54.4 kg) / Rear: 240 lb (109 kg)	Front: 120 lb (54.4 kg) / Rear: 240 lb (109 kg)	Front: 120 lb (54.4 kg) / Rear: 240 lb (109 kg)	Front: 120 lb (54.4 kg) / Rear: 240 lb (109 kg)	Front: 120 lb (54.4 kg) / Rear: 240 lb (109 kg)	Front: 120 lb (54.4 kg) / Rear: 240 lb (109 kg)
	Storage Capacity	10.6 gal (40 L)	10.6 gal (40 L)	10.6 gal (40 L)	10.6 gal (40 L)	10.6 gal (40 L)	10.6 gal (40 L)	10.6 gal (40 L)	10.6 gal (40 L)
	Towing Capacity	1,830 lb (830 kg)	1,830 lb (830 kg)	1,830 lb (830 kg)	1,830 lb (830 kg)	1,830 lb (830 kg)	1,830 lb (830 kg)	1,830 lb (830 kg)	1,830 lb (830 kg)
	Fuel Capacity	5.1 gal (19.5 L)	5.1 gal (19.5 L)	5.1 gal (19.5 L)	5.1 gal (19.5 L)	5.1 gal (19.5 L)	5.1 gal (19.5 L)	5.1 gal (19.5 L)	5.1 gal (19.5 L)
FEATURES	Gauge	7.6 in. wide digital display	7.6 in. wide digital display	7.6 in. wide digital display	7.6 in. wide digital display	10.25 in. touchscreen display	10.25 in. touchscreen display	7.6 in. wide digital display	7.6 in. wide digital display
	Instrumentation	Phone storage & USB charger	Phone storage & USB charger	Phone storage & USB charger	Phone storage & USB charger	Phone storage & USB charger	Phone storage & USB charger	Phone storage & USB charger	Phone storage & USB charger
	Ignition	RF Digitally Encoded Security System (D.E.S.S.™)	RF Digitally Encoded Security System (D.E.S.S.™)	RF Digitally Encoded Security System (D.E.S.S.™)	RF Digitally Encoded Security System (D.E.S.S.™)	RF Digitally Encoded Security System (D.E.S.S.™)	RF Digitally Encoded Security System (D.E.S.S.™)	RF Digitally Encoded Security System (D.E.S.S.™)	RF Digitally Encoded Security System (D.E.S.S.™)
	Lighting	LED headlights and tail lights LED signature	LED headlights and tail lights LED signature	LED headlights and tail lights LED signature	LED headlights and tail lights LED signature	LED headlights and tail lights LED signature	LED headlights and tail lights LED signature	LED headlights and tail lights LED signature	LED headlights and tail lights LED signature
	Winch	3,500 lb (1,588 kg) winch	3,500 lb (1,588 kg) winch	3,500 lb (1,588 kg) winch	3,500 lb (1,588 kg) winch	3,500 lb (1,588 kg) winch with synthetic rope	3,500 lb (1,588 kg) winch	3,500 lb (1,588 kg) winch	3,500 lb (1,588 kg) winch
	Seat	Special Edition seat (color, stitching and material)	Special Edition seat (color, stitching and material)	Special Edition seat (color, stitching and material)	Special edition seat (color, stitching and material)	Special Edition seat (color, stitching and material)	Special edition seat (color, stitching and material)	Standard	Standard
	Handlebar	Aluminum taper-profile handlebar with sport handguards	Aluminum taper-profile handlebar with sport handguards	Aluminum taper-profile handlebar with sport handguards	Aluminum taper-profile handlebar with sport handguards	Standard	Standard	Standard	Standard
Protection	Full skid plate, front bumper, rear bumper	Full skid plate, front bumper, rear bumper	Full skid plate, front bumper, rear bumper	Full skid plate, front bumper, rear bumper	Full skid plate, front bumper, rear bumper	Full skid plate, front bumper, rear bumper	Full skid plate, front bumper, rear bumper	Full skid plate, front bumper, rear bumper	

Cennik zawiera sugerowane ceny detaliczne brutto w walucie PLN. Ceny mogą ulec zmianie bez wcześniejszego uprzedzenia.

Cennik nie jest ofertą w rozumieniu prawa.



RENEGADE 110 EFI

RENEGADE X XC 110 EFI

DS 250



RENEGADE X XC 1000R

RENEGADE X MR 1000R

RENEGADE X XC 650 T ABS

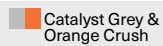
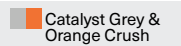
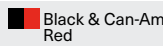
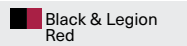
RENEGADE X XC 1000 T ABS

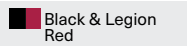
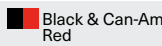
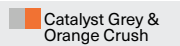

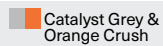
								
ENGINES	Type	112 cc 4-stroke single cylinder, air cooled	112 cc 4-stroke single cylinder, air cooled	250 cc 4-stroke single cylinder, liquid cooled	91 hp, Rotax 976 cc V-twin, liquid cooled	91 hp, Rotax 976 cc V-twin, snorkeled, liquid cooled	59 hp, Rotax 650 cc V-twin, liquid cooled	80 hp, Rotax 976 cc V-twin, liquid cooled
	Fuel Delivery System	Electronic Fuel Injection (EFI) with built-in throttle limiter	Electronic Fuel Injection (EFI) with built-in throttle limiter	Carburetion	Intelligent Throttle Control (iTC™) with Electronic Fuel Injection (EFI)	Intelligent Throttle Control (iTC™) with Electronic Fuel Injection (EFI)	Intelligent Throttle Control (iTC™) with Electronic Fuel Injection (EFI)	Intelligent Throttle Control (iTC™) with Electronic Fuel Injection (EFI)
	Transmission	CVT F / N / R	CVT F / N / R	CVT F / N / R	CVT L / H / N / R / P	CVT Extra low L / H / N / R / P	CVT L / H / N / R / P	CVT L / H / N / R / P
	Drive Train	Chain driven / 2WD Electric starting system	Chain driven / 2WD Electric starting system	Chain driven / solid axle	Selectable 2WD / 4WD with Visco-Lok† QE auto-locking front differential	Selectable 2WD / 4WD / Lock 4WD with Visco-4Lok front differential	Selectable 2WD / 4WD with Brake Traction Control (BTC)	Selectable 2WD / 4WD with Brake Traction Control (BTC)
	Driving assistance	N/A	N/A	N/A	Work / Standard / Sport modes Intelligent Engine Braking (iEB™)	Work / Standard / Sport modes Intelligent Engine Braking (iEB™)	Work / Standard / Sport modes Intelligent Engine Braking (iEB™)	Work / Standard / Sport modes Intelligent Engine Braking (iEB™)
	Power Steering	N/A	N/A	N/A	Tri-Mode Dynamic Power Steering (DPS)	Tri-Mode Dynamic Power Steering (DPS)	Tri-Mode Dynamic Power Steering (DPS)	Tri-Mode Dynamic Power Steering (DPS)
	SUSPENSIONS	Front Suspension	Single A-arm 5 in. (12.7 cm) travel	Double A-arm 5.5 in. (14 cm) travel	Double A-arm 5.5 in. (14 cm) travel	Arched double A-arm with sway bar 9.2 in. (23.3 cm) travel	Arched double A-arm with sway bar 9.2 in. (23.3 cm) travel	Arched double A-arm with sway bar 9.2 in. (23.3 cm) travel
Front Shocks		Twin tube	Gas with piggyback reservoirs	Twin tube	FOX† 1.5 PODIUM† RC2	FOX† 1.5 PODIUM† QS3	FOX† 1.5 PODIUM† RC2	FOX† 1.5 PODIUM† RC2
Rear Suspension		Swingarm 6 in. (15.2 cm) travel	Swingarm 6 in. (15.2 cm) travel	Swingarm 6.7 in. (17 cm) travel	Torsional Trailing arm Independent (TTI) 9.9 in. (25.1 cm) travel	Torsional Trailing arm Independent (TTI) 9.9 in. (25.1 cm) travel	Torsional Trailing arm Independent (TTI) 9.9 in. (25.1 cm) travel	Torsional Trailing arm Independent (TTI) 9.9 in. (25.1 cm) travel
Rear Shocks		Twin tube	Gas	Twin tube	FOX† 1.5 PODIUM† RC2	FOX† 1.5 PODIUM† QS3	FOX† 1.5 PODIUM† RC2	FOX† 1.5 PODIUM† RC2
TIRES / WHEELS	Front & Rear Tires	Front: 19 x 7 x 8 in. Rear: 18 x 9.5 x 8 in.	Front: 19 x 7 x 8 in. Rear: 18 x 9.5 x 8 in.	Front: Kenda 22 x 7 x 10 in. Rear: Kenda 20 x 11 x 9 in.	ITP Holeshott† ATR 25 x 8/11 x 12 in.	ITP Cryptid 30 x 9/9 x 14 in.	ITP Holeshott† ATR 25 x 8/11 x 12 in.	ITP Holeshott† ATR 25 x 8/11 x 12 in.
	Wheels	8 in. steel	8 in. steel	Front: 10 in. black steel / Rear: 9 in. black steel	12 in. cast-aluminum beadlock	14 in. cast-aluminum beadlock	12 in. cast-aluminum beadlock	12 in. cast-aluminum beadlock
BRAKES	Front	Dual drum brakes	Dual drum brakes	Dual hydraulic disc brakes	Dual 214 mm disc brakes with hydraulic twin-piston calipers	Dual 214 mm disc brakes with hydraulic twin-piston calipers	Dual 214 mm disc brakes with hydraulic twin-piston calipers	Dual 214 mm disc brakes with hydraulic twin-piston calipers
	Rear	Single drum brakes	Single drum brakes	Single hydraulic disc brake	Single 214 mm disc brake with hydraulic twin-piston caliper	Single 214 mm disc brake with hydraulic twin-piston caliper	Single 214 mm disc brake with hydraulic twin-piston caliper	Single 214 mm disc brake with hydraulic twin-piston caliper
DIMENSIONS / CAPACITIES	Estimated Dry Weight *	295 lb (134 kg)	310 lb (140 kg)	429 lb (195 kg)	795 lb (361 kg)	971 lb (440 kg)	802.6 lb (364 kg)	812.6 lb (368.6 kg)
	L x W x H (includes mirrors)	60.6 x 40.4 x 38.6 in. (154 x 103 x 98 cm)	60.6 x 42 x 38.6 in. (154 x 108 x 98 cm)	72 x 40.5 x 43.5 in. (183 x 103 x 110.5 cm)	86 x 48 x 49 in. (218.4 x 121.9 x 124 cm)	83 x 50 x 56 in. (224 x 127 x 131 cm)	87 x 48 x 58.2 in. (218.4 x 121.9 x 147.8 cm)	88 x 48 x 58.2 in. (218.4 x 121.9 x 147.8 cm)
	Wheelbase	41 in. (105 cm)	41 in. (105 cm)	47 in. (118.7 cm)	51 in. (129.5 cm)	51 in. (129.5 cm)	51 in. (129.5 cm)	51 in. (129.5 cm)
	Ground Clearance	8.3 in. (21.1 cm) under frame / 4.5 in. (11.4 cm) under rear axle	8.3 in. (21.1 cm) under frame / 4.5 in. (11.4 cm) under rear axle	10.2 in. (26 cm) center of ATV / 4.5 in. (11.4 cm) under rear axle	10.5 in. (26.7 cm)	12.5 in. (31.8 cm)	10.5 in. (26.7 cm)	10.5 in. (26.7 cm)
	Seat Height	28 in. (71 cm)	28 in. (71 cm)	31.5 in. (80 cm)	34.5 in. (87.7 cm)	36.8 in. (93.3 cm)	34.5 in. (87.7 cm)	34.5 in. (87.7 cm)
	Rack Capacity	N/A	N/A	N/A	Rear: 35 lb (16 kg)	Rear: 35 lb (16 kg)	Rear: 35 lb (16 kg)	Rear: 35 lb (16 kg)
	Storage Capacity	N/A	N/A	N/A	N/A	N/A	N/A	N/A
	Towing Capacity	N/A	N/A	N/A	1,300 lb (590 kg)	1,300 lb (590 kg)	N/A	N/A
Fuel Capacity	1.6 gal (6 L)	1.6 gal (6 L)	3.3 gal (12.5 L)	5.4 gal (20.5 L)	5.4 gal (20.5 L)	5.4 gal (20.5 L)	5.4 gal (20.5 L)	
FEATURES	Gauge	Neutral, reverse, fuel level & check engine lights	Neutral, reverse, fuel level & check engine lights	Neutral light, reverse light and oil / temperature light	4.5 in. digital display	4.5 in. digital display	4.5 in. digital display	4.5 in. digital display
	Instrumentation	N/A	N/A	N/A	DC outlet, 15-A connector	DC outlet, 15-A connector	DC outlet, 15-A connector	DC outlet, 15-A connector
	Ignition	Mechanical key	Mechanical key	Mechanical key	RF Digitally Encoded Security System (D.E.S.S.™)	RF Digitally Encoded Security System (D.E.S.S.™) with cord	RF Digitally Encoded Security System (D.E.S.S.™)	RF Digitally Encoded Security System (D.E.S.S.™)
	Lighting	Halogen running headlights	Halogen running headlights	2 headlamps (35 W) with tail lights and brake lights	LED headlights	LED headlights	LED headlights	LED headlights
	Winch	N/A	N/A	N/A	Prewired for available winch	3,500-lb (1,588 kg) winch	N/A	N/A
	Seat	Standard	Standard	Standard	Standard	Standard	Standard	Standard
	Handlebar	Ergonomics & controls sized for 10 years old and up	Sport handguards Ergonomics & controls sized for 10 years old and up	Standard	Aluminum taper-profile handlebar with full wrap handguards	Aluminum taper-profile handlebar with grab handle and full wrap handguards	Aluminum taper-profile handlebar with full wrap handguards	Aluminum taper-profile handlebar with full wrap handguards
	Protection	Front bumper	Front bumper	N/A	Front bumper Front & central skid plate	Front bumper, rear bumper Mudguards aluminum skid plate	Mudguards Front (plastic) & central (aluminum) skid plate	Mudguards Front (plastic) & central (aluminum) skid plate

Cennik zawiera sugerowane ceny detaliczne brutto w walucie PLN. Ceny mogą ulec zmianie bez wcześniejszego uprzedzenia.
Cennik nie jest ofertą w rozumieniu prawa.



**OUTLANDER 6X6
XU+ 450 T**

Tundra Green



**OUTLANDER 6X6
XU+ 650 T**

Tundra Green



**OUTLANDER 6X6
XU+ 1000 T**

Boreal Green



**OUTLANDER MAX 6X6
XU+ 650 T**

Tundra Green



**OUTLANDER MAX 6X6
XU+ 1000 T**

Boreal Green

	OUTLANDER 6X6 XU+ 450 T	OUTLANDER 6X6 XU+ 650 T	OUTLANDER 6X6 XU+ 1000 T	OUTLANDER MAX 6X6 XU+ 650 T	OUTLANDER MAX 6X6 XU+ 1000 T	
ENGINES	Type	38 hp, Rotax 427 cc single cylinder, liquid cooled	59 hp, Rotax 650 cc V-twin, liquid cooled	80 hp, Rotax 976 cc V-twin, liquid cooled	59 hp, Rotax 650 cc V-twin, liquid cooled	80 hp, Rotax 976 cc V-twin, liquid cooled
	Fuel Delivery System	Intelligent Throttle Control (iTC™) with Electronic Fuel Injection (EFI)	Intelligent Throttle Control (iTC™) with Electronic Fuel Injection (EFI)	Intelligent Throttle Control (iTC™) with Electronic Fuel Injection (EFI)	Intelligent Throttle Control (iTC™) with Electronic Fuel Injection (EFI)	Intelligent Throttle Control (iTC™) with Electronic Fuel Injection (EFI)
	Transmission	CVT Extra low L / H / N / R / P	CVT Extra low L / H / N / R / P	CVT Extra low L / H / N / R / P	CVT Extra low L / H / N / R / P	CVT Extra low L / H / N / R / P
	Drive Train	Selectable 4WD / 6WD with Visco-Lok† QE auto-locking front differential	Selectable 4WD / 6WD / Lock 4WD with Visco-4Lok front differential	Selectable 4WD / 6WD / Lock 4WD with Visco-4Lok front differential	Selectable 4WD / 6WD / Lock 4WD with Visco-4Lok front differential	Selectable 4WD / 6WD / Lock 4WD with Visco-4Lok front differential
	Driving assistance	Speed limiter	Work / Standard / Sport modes Intelligent Engine Braking (iEB™) Speed limiter	Work / Standard / Sport modes Intelligent Engine Braking (iEB™) Speed limiter	Work / Standard / Sport modes Intelligent Engine Braking (iEB™) Speed limiter	Work / Standard / Sport modes Intelligent Engine Braking (iEB™) Speed limiter
	Power Steering	Tri-Mode Dynamic Power Steering (DPS)	Tri-Mode Dynamic Power Steering (DPS)	Tri-Mode Dynamic Power Steering (DPS)	Tri-Mode Dynamic Power Steering (DPS)	Tri-Mode Dynamic Power Steering (DPS)
SUSPENSIONS	Front Suspension	Arched Double A-arm with sway bar 10.8 in. (27.4 cm) travel	Arched Double A-arm with sway bar 10.8 in. (27.4 cm) travel	Arched Double A-arm with sway bar 10.8 in. (27.4 cm) travel	Arched Double A-arm with sway bar 10.8 in. (27.4 cm) travel	Arched Double A-arm with sway bar 10.8 in. (27.4 cm) travel
	Front Shocks	Twin tube	Twin tube	Twin tube	Twin tube	Twin tube
	Rear Suspension	Double Torsional Trailing arm Independent (TTI2) with quick-release sway bar 8.8 in. (22.4 cm) travel	Double Torsional Trailing arm Independent (TTI2) with quick-release sway bar 9.9 in. (25.1 cm) travel	Double Torsional Trailing arm Independent (TTI2) with quick-release sway bar 9.9 in. (25.1 cm) travel	Double Torsional Trailing arm Independent (TTI2) with quick-release sway bar 9.9 in. (25.1 cm) travel	Double Torsional Trailing arm Independent (TTI2) with quick-release sway bar 9.9 in. (25.1 cm) travel
	Rear Shocks	Twin tube	Twin tube	Twin tube	Twin tube	Twin tube
TIRES / WHEELS	Front & Rear Tires	Carlisle ACT HD 26 x 8/10 x 12 in.	ITP† Terracross 26 x 8/10 x 14 in.	ITP† Terracross 26 x 8/10 x 14 in.	ITP† Terracross 26 x 8/10 x 14 in.	ITP† Terracross 26 x 8/10 x 14 in.
	Wheels	12 in. cast aluminum	14 in. cast-aluminum	14 in. cast-aluminum	14 in. cast-aluminum	14 in. cast-aluminum
BRAKES	Front	Dual 214 mm disc brakes with hydraulic twin-piston calipers	Dual 214 mm disc brakes with hydraulic twin-piston calipers	Dual 214 mm disc brakes with hydraulic twin-piston calipers	Dual 214 mm disc brakes with hydraulic twin-piston calipers	Dual 214 mm disc brakes with hydraulic twin-piston calipers
	Rear	Single 214 mm disc brake with hydraulic twin-piston caliper	Dual 214 mm disc brakes with hydraulic twin-piston calipers	Dual 214 mm disc brakes with hydraulic twin-piston calipers	Dual 214 mm disc brakes with hydraulic twin-piston calipers	Dual 214 mm disc brakes with hydraulic twin-piston calipers
DIMENSIONS / CAPACITIES	Estimated Dry Weight *	977 lb (443 kg)	1,265 lb (574 kg)	1,270 lb (576 kg)	1,312 lb (595 kg)	1,316 lb (597 kg)
	L x W x H (includes mirrors)	109.8 x 46.8 x 58 in. (279 x 118.8 x 147.4 cm)	117 x 48 x 58.8 in. (297 x 122 x 149.4 cm)	117 x 48 x 58.8 in. (297 x 122 x 149.4 cm)	124.8 x 48.4 x (317 x 123 x 163.4 cm)	317 x 123 x 163.4 cm
	Wheelbase	81.9 in. (208 cm)	81.9 in. (208 cm)	81.9 in. (208 cm)	90 in. (228.5 cm)	90 in. (228.5 cm)
	Ground Clearance	10.5 in. (26.7 cm)	11 in. (27.9 cm)	11 in. (27.9 cm)	11 in. (27.9 cm)	11 in. (27.9 cm)
	Seat Height	33.8 in. (85.8 cm)	34.5 in. (87.7 cm)	34.5 in. (87.7 cm)	34.5 in. (87.7 cm)	34.5 in. (87.7 cm)
	Rack Capacity	Front: 54 kg / Rear: 159kg	Front: 45 kg / Rear: 318kg	Front: 45 kg / Rear: 318 kg	Front: 45 kg / Rear: 318 kg	Front: 45 kg / Rear: 318 kg
	Storage Capacity	2.9 gal (10.9 L)	Dual-level cargo box with sidewalls and tailgate Rear: 18.5 gal (70 L)	Dual-level cargo box with sidewalls and tailgate Rear: 18.5 gal (70 L)	Dual-level cargo box with sidewalls and tailgate Rear: 18.5 gal (70 L)	Dual-level cargo box with sidewalls and tailgate Rear: 18.5 gal (70 L)
	Towing Capacity	2,000 lb (907 kg) trailer with brakes 1,025 lb (465 kg) trailer without brakes	2,000 lb (907 kg) trailer with brakes 1,486 lb (674 kg) trailer without brakes	2,000 lb (907 kg) trailer with brakes 1,486 lb (674 kg) trailer without brakes	2,000 lb (907 kg) trailer with brakes 1,486 lb (674 kg) trailer without brakes	2,000 lb (907 kg) trailer with brakes 1,486 lb (674 kg) trailer without brakes
Fuel Capacity	5.4 gal (20.5 L)	5.4 gal (20.5 L)	5.4 gal (20.5 L)	5.4 gal (20.5 L)	5.4 gal (20.5 L)	
FEATURES	Gauge	4.5 in. digital display	4.5 in. digital display	4.5 in. digital display	4.5 in. digital display	4.5 in. digital display
	Instrumentation	DC outlet, 15-A connector	DC outlet, 15-A connector	DC outlet, 15-A connector	DC outlet, 15-A connector	DC outlet, 15-A connector
	Ignition	RF Digitally Encoded Security System (D.E.S.S.™)	RF Digitally Encoded Security System (D.E.S.S.™)	RF Digitally Encoded Security System (D.E.S.S.™)	RF Digitally Encoded Security System (D.E.S.S.™)	RF Digitally Encoded Security System (D.E.S.S.™)
	Lighting	70-W headlights	LED headlights	LED headlights	LED headlights	LED headlights
	Winch	3,500-lb (1,588 kg) winch	3,500-lb (1,588 kg) winch	3,500-lb (1,588 kg) winch	3,500-lb (1,588 kg) winch	3,500-lb (1,588 kg) winch
	Seat	Reinforced seat skin	Reinforced seat skin	Reinforced seat skin	Reinforced seat skin Convertible Rack System (CRS)	Reinforced seat skin Convertible Rack System (CRS)
	Handlebar	Standard with heated grips & throttle	Standard with heated grips & throttle	Standard with heated grips & throttle	Standard with heated grips & throttle	Standard with heated grips & throttle
Protection	Heavy-duty front bumper	Heavy-duty front bumper	Heavy-duty front bumper	Heavy-duty front bumper	Heavy-duty front bumper	

Cennik zawiera sugerowane ceny detaliczne brutto w walucie PLN. Ceny mogą ulec zmianie bez wcześniejszego uprzedzenia.

Cennik nie jest ofertą w rozumieniu prawa.





G2, G2L, G2S ACCESSORIES

LinQ: Easy On, Easy Off Cargo	16
Racks & Holders	21
Cargo & Storage	22
Can-Am Windshields	24
Handlebars & Mirrors	25
Seats	26
HMWPE Skid Plates	27
Plastic Skid Plates	28
Aluminum Skid Plates	29
HMWPE & Aluminum Skid Plates	31
Bumpers & Guards	32
Lights & Electrical	34
Winches	37
Hitches	39
Performance	40
Covers, Decals & Add-Ons	42
Apache Track Systems	44
ProMount Plows	48



BUNDLE UP TO NEVER COMPROMISE. YOUR ATV BUNDLES.

STEP 1: CHOOSE YOUR ESSENTIAL BUNDLE

		G2L G2L MAX	G2 G2 MAX
STARTER	LinQ Base	715002350	N/A
	LinQ 23 Gal (86 L) Trunk Box	715004923	715004923
	Handlebar Wind Deflectors	715001706	715001706
ADVANCED	LinQ Heavy-Duty Basket	715001215	715001215
	LinQ Tool Kit	715006829	715006829
	Handlebar Mirrors	715005366	715005366
PEAK	Bluetooth Handlebar Soundbar by MTX	219400840	219400840

STEP 2: PICK YOUR ADD-ON BUNDLE

		G2L G2L MAX	G2 G2 MAX
ADVENTURE	Self-Clearing Footwells	715004759	715004759
	Electronic Device Holder	715004919	715004919
	Storage 2.6 Gal (10 L) Bag	269502121	269502121
	Fender Flares	715004487	N/A
	Mud Flaps	N/A	715007089
HUNT	LinQ Gear Grips	715005340	715005340
	Gun Boot Rack	715001918	715002113
	Gun Boot 6.0 Impact by Kolpin	715001419	715001419
	Expedition Front Bumper	715007233	715007233
WORK	Large Cargo Box	715007001	715007001
	LinQ Tool Holder	715007358	715007358
	USB Power Outlet Kit	219400510	219400510
	Ratchet Tie-Downs	715008309	715008309
WINTER	Seat Heater	715007211	715007211
	Heavy-Duty Seat Cover	715007212	715007212
	High Windshield Kit	715006382	715006382

© 2024 Bombardier Recreational Products Inc. All rights reserved. ®, TM and the BRP logo are trademarks of Bombardier Recreational Products Inc. or its affiliates. Because of its ongoing commitment to product quality and innovation, BRP reserves the right, at any time, to discontinue or change specifications, prices, designs, features, models or equipment without incurring any obligation.

Cennik zawiera sugerowane ceny detaliczne brutto w walucie PLN. Ceny mogą ulec zmianie bez wcześniejszego uprzedzenia.
Cennik nie jest ofertą w rozumieniu prawa.

LINQ: EASY ON, EASY OFF CARGO

LINQ ACCESSORIES

Compatibility/requirements

<ul style="list-style-type: none"> No tools needed: Quickly install and remove accessories by hand. Equip your Can-Am for specialized tasks in no time. Sturdy mounting system that holds up to the roughest terrain. 	OUTLANDER 450/570	OUTLANDER	RENEGADE
LinQ Accessories with 16" Base <ul style="list-style-type: none"> LinQ anchors mounted 16 inches apart, center-to-center. Lower loading capacity than the LinQ with 36" base accessories. Can be used on Can-Am ATV and SxS vehicles, Can-Am Spyder and Ryker vehicles, Sea-Doo watercraft and Ski-Doo snowmobiles. 			
LinQ 4.2 Gal (16 L) Cooler 219400964 • Black / 295100698 • White			
LinQ Tool Box 715008111			LinQ Luggage Rack 715001734
LinQ SR 5.5 Gal (21 L) Bag 860202449			& LinQ Anchor Adapter Kit 715004960
LinQ 4.5 Gal (17 L) Sport Bag 860202447	LinQ Adapter Plate 715007273	LinQ Anchor Adapter Kit 715004960	OR
LinQ Modular Box 715005494 • (10 L) 715007112 • (20 L) 715006830 • (30 L)	& LinQ Base Installation Kit 715008125	& LinQ Base Installation Kit 715008125	LinQ Adapter Plate 715007274
LinQ Tool Kit 715006829			& LinQ Base Installation Kit 715008125
LinQ Roll-Top Bag 715008110			
LinQ Accessories with 36" Base <ul style="list-style-type: none"> Mount on LinQ racks often used by Can-Am ORV vehicles. Higher loading capacity than the LinQ with 16" base accessories. Usage is limited to Can-Am ORV vehicles. 			
LinQ 12 Gal (45 L) Cargo Box 715003879	LinQ Base 715002350		
LinQ 23 Gal (86 L) Trunk Box 715004923			
LinQ 32 Gal (121 L) Trunk Box 715001747 (1-up) 715001749 (MAX)	No compatibility		
LinQ 11.5 Gal (43 L) Audio Cargo Box 715003018	LinQ Base 715002350	No further requirements	LinQ Luggage Rack 715001734
LinQ 8 Gal (30 L) Cooler Box 715004778 • Black / 715004698 • Gray	No compatibility		
LinQ Premium Storage Bag by OGIO 715002923 • Black			
LinQ Heavy Duty Basket 715001215	LinQ Base 715002350		
LinQ Low Profile Basket 715004282			
LinQ Holders			
LinQ 4" (10 cm) Rack Extension 715001711 • Silver / 715001665 • Black	Not compatible <i>*Alternative 5" or 8" Rack Extensions (715001913 or 715001914) are available for G2L</i>		
LinQ 6" (15 cm) Rack Extension 715001712 • Silver / 715001671 • Black			LinQ Luggage Rack 715001734
LinQ Mounted Gear Grips 715005340	LinQ Base 715002350	No further requirements	
LinQ Tool Holder 715007358			
LinQ Gun Boot Rack 715002112 715002113	Not compatible <i>*Alternative Gun Boot Racks (715001918 or 715001919) are available for G2L</i>		No compatibility

Cennik zawiera sugerowane ceny detaliczne brutto w walucie PLN. Ceny mogą ulec zmianie bez wcześniejszego uprzedzenia.
Cennik nie jest ofertą w rozumieniu prawa.

LinQ Accessories with 16" Base

LinQ Modular Box	G2, G2L, G2S	715005494 · (10 L) 643,00 zł 715007112 · (20 L) 729,00 zł 715006830 · (30 L) 822,00 zł
	<ul style="list-style-type: none"> • Allows stacking of other modular boxes to always have the right gear accessible. • Always have the right box size to fit everything. • Can be installed on any LinQ Base with a 16" width. • See table for installation location and requirements. 	
Thermal Insert for LinQ Modular Box (10 L)	G2, G2L, G2S	219401110 294,00 zł
	<ul style="list-style-type: none"> • Insulated liner. • Fits very well in the LinQ Modular Box (10 L). • Can contain seven 355 ml cans. • Keeps ice cold for one day. • Interior dimensions : 9" L x 17" W x 2½" H. 	
LinQ Tool Kit	G2, G2L, G2S	715006829 1 619,00 zł
	<ul style="list-style-type: none"> • Includes: <ul style="list-style-type: none"> - Cutter pliers - Long-nose pliers - Locking pliers - Ratchet wrench ¾" drive - 6" ratchet extension - Integrated CVT belt storage location (belt not included) - Long-socket 19 mm ¾" drive - 6 pts - Socket 18 mm ¾" drive - Long-socket 17 mm ¾" drive - 6 pts - Socket 15 mm ¾" drive - Socket 13 mm ¾" drive - Socket 10 mm ¾" drive - Socket 8 mm ¾" drive - Socket Torx T40 ¾" drive - Socket Torx T30 ¾" drive - Socket Torx T20 ¾" drive - Breaker bar ¾" drive - Combination Wrench set: <ul style="list-style-type: none"> - Wrench 19 mm - Wrench 18 mm - Wrench 15 mm - Wrench 13 mm - Wrench 10 mm - Wrench 8 mm • See table for installation location and requirements. 	
LinQ 4.2 Gal (16 L) Cooler	G2, G2L, G2S	219400964 · Black 1 810,00 zł 295100698 · White
	<ul style="list-style-type: none"> • All the benefits of LinQ—simple, fast and secure. • Rotomolded construction for exceptional rigidity and durability. • Premium-quality foam insulation for optimal ice retention. • Uses LinQ mounting system (Patent US 8777531 and US 8875830). • Easy one-second on/off tool-less system. • Can contain twenty 355 ml cans. • Keeps ice cold for three days. • Exterior dimensions: 13" L x 20" W x 10" H. • Interior dimensions : 9" L x 17" W x 7" H. • See table for installation location and requirements. 	
LinQ Tool Box	G2, G2L, G2S	715008111 822,00 zł
	<ul style="list-style-type: none"> • High precision injected HDPE construction provides rigidity and durability. • 5 gal (19 L) maximum capacity. • Weather-resistant, sealed and lockable cover. • Easy one-second on/off tool-less system. • All the benefits of LinQ – simple, fast and secure. • See table for installation location and requirements. 	
LinQ Roll-Top Bag	G2, G2L, G2S	715008110 1 053,00 zł
	<ul style="list-style-type: none"> • Fully waterproof Roll-Top dry bag will securely store and confine your equipment. • LinQ mounted using heavy-duty rigid plastic base. • High capacity storage solution 10.6 gal (40 L). • Bottom foam liner for additional equipment protection. • Integrated handle for easy transportation on/off the vehicle. • Marineized for salt water purposes. • Dimensions: 14" L x 19" W x adjustable H. • See table for installation location and requirements. 	

Cennik zawiera sugerowane ceny detaliczne brutto w walucie PLN. Ceny mogą ulec zmianie bez wcześniejszego uprzedzenia.
Cennik nie jest ofertą w rozumieniu prawa.

SR 5.5 Gal (21 L) LinQ Bag	G2, G2L, G2S	860202449	1 053,00 zł
-----------------------------------	--------------	------------------	-------------



- Semi-rigid expandable bag.
- 5.5 gal (21 L) capacity.
- See table for installation location and requirements.

LinQ 4.5 Gal (17 L) Sport Bag	G2, G2L, G2S	860202447	960,00 zł
--------------------------------------	--------------	------------------	-----------



- All the benefits of LinQ – simple, fast and secure.
- 17 liter (4.5 US gallon) capacity.
- Thermoformed bag base in HDPE (High Density Polyethylene) providing rigidity and durability.
- Premium insulating foam for optimal ice retention.
- Rigid bottom, semi-rigid top.
- Easy one-second on/off tool-less system.
- See table for installation location and requirements.

LinQ Accessories with 36" Base

LinQ 12 Gal (45 L) Cargo Box	G2 (front only for 6x6 & MAX models 2013-2014), G2L, G2S	715003879	1 457,00 zł
-------------------------------------	--	------------------	-------------



- LinQ mounted for easy on, easy off installation.
- Holds cargo safely and securely while riding.
- See table for installation location and requirements.

LinQ 23 Gal (86 L) Trunk Box	G2 (except 6x6 models), G2L, G2S	715004923	1 689,00 zł
-------------------------------------	----------------------------------	------------------	-------------



- LinQ mounted for easy on, easy off installation.
- Lockable and weather-resistant.
- Holds cargo safely and securely while riding.
- Comfort pads for passenger.
- See table for installation location and requirements.

LinQ 32 Gal (121 L) Trunk Box	G2 (except MAX models & 6x6), G2S	715001747	2 648,00 zł
	European Version (EC compliant)	715001748 · No rear tail light.	2 405,00 zł



- LinQ Retrofit Adapter Plate (715001334) is required for G1 models.
- Trunk Box Panels available in many colors to match your vehicle (sold separately).
- See table for installation location and requirements.

LinQ 32 Gal (121 L) Trunk Box for Outlander Max	G2 (MAX models only except 6x6 models)	715001749	3 094,00 zł
	European Version (EC compliant)	715001750 · No rear tail light.	3 094,00 zł



- Passenger comfort is ensured on active rides as well as longer recreational rides thanks to the ergonomically designed passenger padding, which is comfort-fitted with a portion made of closed cell foam that won't absorb water.
- Very easy to embark even when driver is seated.
- Trunk Box Panels available in many colors to match your vehicle (sold separately).

LinQ 32 Gal (121 L) Trunk Box Panels	G2 (except 6x6 models), G2S		
---	-----------------------------	--	--



- Color panels to match the LinQ 32 Gal (121 L) Trunk Box to your vehicle.

■ 715001391 · Black	316,00 zł	■ 715002985 · Manta Green	316,00 zł
■ 715001392 · Yellow	316,00 zł	■ 715002986 · Can-Am Red	316,00 zł
□ 715002481 · White	316,00 zł	■ 715006119 · Orange Crush	316,00 zł
■ 715002480 · Light Gray	316,00 zł	■ 715006120 · Squadron Green	320,00 zł
■ 715002984 · Octane Blue	316,00 zł	■ 715007074 · Tundra Green	320,00 zł

Cennik zawiera sugerowane ceny detaliczne brutto w walucie PLN. Ceny mogą ulec zmianie bez wcześniejszego uprzedzenia.
Cennik nie jest ofertą w rozumieniu prawa.

LinQ 32 Gal (121 L) Trunk Box Panels

(Not illustrated)

EUROPEAN VERSION (EC compliant)

- Color panels to match the LinQ 32 Gal (121 L) Trunk Box to your vehicle.
- No rear tail light.

■ 715001397 · Black	316,00 zł	■ 715006122 · Manta Green	316,00 zł
■ 715001398 · Yellow	316,00 zł	■ 715006121 · Can-Am Red	316,00 zł
■ 715006124 · Viper Red	316,00 zł	■ 715006123 · Orange Crush	316,00 zł
□ 715002483 · White	316,00 zł		

LinQ 11.5 Gal (43 L) Audio Cargo Box

G2 (front only for 6x6 & MAX models 2013-2014), G2L, G2S

715003018 4 215,00 zł



- Mounts on/off easily to hold/carry cargo safely and securely.
- The Bluetooth enabled receiver and 6.5" (16.5 cm) speakers are smartly concealed and integrated in the cover.
- Automatic shut-off function protects your battery by turning the system off after 10 minutes of inactivity.
- Backlit control panel perfect for night riding.
- Water-resistant speakers.
- Delivers the best sound quality on the market to sweeten your ride courtesy of a built-in full range high-efficiency amplifier.
- See table for installation location and requirements.

LinQ 8 Gal (30 L) Cooler Box

G2 (except 6x6 models), G2S

■ **715004778** · Black 2 203,00 zł
■ **715004698** · Gray 2 203,00 zł



- LinQ mounted for easy on, easy off installation.
- Rotomolded construction provides exceptional rigidity and durability.
- Premium-quality foam insulation for optimal ice retention.
- Integrated, fully-removable compartment protects food.
- Robust rubber latches keep the cover tightly closed.
- Weather-resistant.
- Convenient drain plug.
- See table for installation location and requirements.

LinQ Premium Storage Bag by OGIO

G2 (except 6x6 models), G2L, G2S

■ **715002923** · Black 2 279,00 zł



- LinQ mounted for easy on, easy off installation.
- Holds cargo safely and securely while riding.
- See table for installation location and requirements.

LinQ Low Profile Basket

G2, G2L (front only for MAX & 6x6 models), G2S

715004282 1 030,00 zł



- Low profile, open basket increases cargo space.
- Perfect for easy access to tools, rope, winch and plow accessories.
- Multiple bungee cord and tie-down anchor points.
- Made of impact-resistant injected polypropylene.
- See table for installation location and requirements.

LinQ Heavy-Duty Basket

G2, G2L (front only for MAX & 6x6 models), G2S

715001215 1 371,00 zł



- Made of high-strength, low-alloy steel.
- LinQ mount for easy on, easy off installation.
- Can be placed on both front and back racks of vehicle.
- See table for installation location and requirements.

Large Cargo Box

G2, G2L (except 6x6)

715007001 3 128,00 zł



- Rear bed to carry large items.
- Anchor points (D-ring), LinQ fixtures for tool holder, and marks to allow the installation of a 16" accessory.
- Also has a mat for the floor and slot to enable the installation of a divider and a slot for a divider to close the recess on the rear vertical lip.
- It is installed on ATV platforms through the LinQ system and hooks to make it easily installable and removable.

Installation of some accessories shown may impact vehicle compliance with some regulations. Consult your local dealer for information.

LinQ Holders

LinQ Tool Holder | G2, G2L, G2S | **715007358** | 294,00 zł



- Ultra-versatile tool holder.
- Convenient swivel-latch allows tools to be stored in any orientation.
- Sold in pairs.
- G2S: LinQ Luggage Rack (715001734) is required for installation.

LinQ Gear Grips | G2, G2L, G2S | **715005340** | 793,00 zł



- Durable and flexible grips provide a custom fit for a variety of items from 1" to 4" (2.5 cm to 10 cm) in diameter.
- Heavy-duty design for carrying bows, fishing poles, rakes, farm tools and more.
- Quick-release button opens grip quickly for easy access to gear.
- Heavy-duty base system built for the toughest adventures.
- Make transporting your tools a snap by combining the Gear Grips with the LinQ system.
- 360° orientation.
- Sold in pairs.

LinQ Mounting

LinQ Anchor Adapter Kit | G2, G2S | **715004960** | 394,00 zł



- Allows the installation of accessories with LinQ Base of 16" on LinQ racks.
- Tool-less installation and removal.
- For G2S, the LinQ Luggage Rack (715001734) is required for installation.

LinQ Base | G2L | **715002350** | 121,00 zł



- Made of glass fiber reinforced polypropylene.
- Allows you to install LinQ accessories.
- Sold in pack of 4.

LinQ Lock | G2, G2L, G2S | **860201968** | 305,00 zł



- Simple way to securely lock most LinQ accessories.
- Lock cover protects lock from the elements.
- Corrosion resistant.
- Pack of 1, includes 2 keys.
- Not compatible with LinQ 4.2 US Gal (16 L) Cooler, LinQ Tool Box, LinQ Tool Holder and LinQ Gear Grips.







LinQ Replacement Parts | **715001707** | 158,00 zł



- Unique mounting fastener usable on any LinQ system accessory.
- Tool-less installation and removal.
- Sold in pairs.

Cennik zawiera sugerowane ceny detaliczne brutto w walucie PLN. Ceny mogą ulec zmianie bez wcześniejszego uprzedzenia.
Cennik nie jest ofertą w rozumieniu prawa.

RACKS & HOLDERS

LinQ Rack Extension – 4" (10 cm)	G2, G2S	■ 715001711 · Silver ■ 715001665 · Black 1 174,00 zł
	<ul style="list-style-type: none"> • Fits front or rear. • Strong and durable. • Helps keep cargo securely in place. • Easy and tool-less installation thanks to the LinQ system. • Anti-corrosion coating with durable powder coat finish. • LinQ Luggage Rack (715001734) is required for G2S. 	
LinQ Rack Extension – 6" (15 cm)	G2, G2S	■ 715001712 · Silver ■ 715001671 · Black 1 226,00 zł
	<ul style="list-style-type: none"> • Fits front or rear. • Strong and durable. • Helps keep cargo securely in place. • Easy and tool-less installation thanks to the LinQ system. • Anti-corrosion coating with durable powder coat finish. • LinQ Luggage Rack (715001734) is required for G2S. 	
Rack Extension – 5" (13 cm)	G2L	715001913 671,00 zł
	<ul style="list-style-type: none"> • Fits front or rear. • Made of carbon steel. • Provides tie-down points to secure cargo on racks. • Easy installation on tubular rack. • Anti-corrosion coating with durable powder coat finish. 	
Rack Extension – 8" (20 cm)	G2L	715001914 781,00 zł
	<ul style="list-style-type: none"> • Fits front or rear. • Made of carbon steel. • Provides tie-down points to secure cargo on racks. • Easy installation on tubular rack. • Anti-corrosion coating with durable powder coat finish. 	
LinQ Luggage Rack	G2S (except X mr models)	715001734 1 567,00 zł
	<ul style="list-style-type: none"> • Bolt-on rack. • Enables use of LinQ mounted accessories on the G2S. 	
LinQ Base Plate	G2L	715007273 590,00 zł
	<ul style="list-style-type: none"> • Enables use of 16" wide LinQ Base accessories on G2L to extend cargo options and journey opportunities. • Requires LinQ Base Kit (715008125). 	
LinQ Base Plate	G2S	715007274 735,00 zł
	<ul style="list-style-type: none"> • Enables use of 16" wide LinQ Base accessories on G2S to extend cargo options and journey opportunities. • Requires LinQ Base Kit (715008125). 	

Cennik zawiera sugerowane ceny detaliczne brutto w walucie PLN. Ceny mogą ulec zmianie bez wcześniejszego uprzedzenia.
Cennik nie jest ofertą w rozumieniu prawa.

Gun Boot Rack	G2L (except MAX models)	715001918	758,00 zł
	G2L (MAX models only)	715001919	



- Made of steel.
- Designed for the tubular rack.
- For use with Gun Boot 6.0 Impact by Kolpin.
- Can be mounted to either side of the vehicle.

Gun Boot 6.0 Impact[†] by Kolpin[†]	G2, G2L	715001419	585,00 zł
--	---------	------------------	-----------



- Extra room for pistol-grip-type weapons and small bipods.
- Easily fits firearms up to 51" (130 cm) in total length.
- Provides ample room for 2 $\frac{3}{8}$ " (60 mm) scopes.
- Hatchback design allows easy access.
- Ergonomically designed handle and molded attachment points for sling.
- Snap-close cover with locking capability.
- Designed to accommodate left and right hand bolt-action rifles and shotguns.
- Includes removable, shock absorbing foam and nylon impact liner for superior interior protection.
- Requires appropriate mounting kit for installation.

LinQ Gun Boot Rack <i>(Not illustrated)</i>	G2 (except MAX, 6x6 & X mr 1000)	715002112	909,00 zł
	G2 (MAX & X mr 1000 models only)	715002113	735,00 zł

- This lightweight Gun Boot Rack can be mounted on either side of your Outlander using the tool-less LinQ system.
- For use with Gun Boot 6.0 Impact by Kolpin.

Multi-Fit Holder	G2, G2L	715002354 · Single	309,00 zł
		715001945 · Double	492,00 zł



- Open U-shaped bracket for carrying tools (shovel, axe) and hunting weapons (rifle, bow) that are safely secured, but easily accessible.
- Easy installation on tubular rack, extension racks, basket or bumpers.
- For G2, the LinQ Rack Extension (715001711) is required.
- Sold in pairs.

LinQ Gear Grips	G2L	715001421	492,00 zł
------------------------	-----	------------------	-----------



- Durable, flexible grips cushion and protect while providing a custom fit for a variety of items from 1" to 4" (2.5 cm to 10 cm) in diameter.
- Heavy-duty design for carrying bows, fishing poles, rakes, farm tools and more.
- Quick-release button opens grip quickly for easy access to gear.
- Heavy-duty base system built for the toughest adventures.
- Easy installation on tubular racks, extension racks, brackets or bumpers.
- Sold in pairs.

CARGO & STORAGE

Hard Top	G2 (6x6 models only)	715002394	5 377,00 zł
-----------------	----------------------	------------------	-------------



- The hard top provides a 116 gal (440 L) cargo box.
- Locking secures your belongings.
- The cover raises assisted by gas cylinders.

Side Walls & Tailgate	G2 (6x6 models only)	715005153	5 476,00 zł
----------------------------------	----------------------	------------------	-------------



- Allows for a quick and easy conversion of the cargo bed into a trunk with plenty of room.
- Rotationally molded walls provide extreme durability for hard work - in all conditions.

Cargo Protection Wall <i>(Not illustrated)</i>	G2 (6x6 models only)	708301522	1 619,00 zł
--	----------------------	------------------	-------------

- Fits with or without side walls

Cennik zawiera sugerowane ceny detaliczne brutto w walucie PLN. Ceny mogą ulec zmianie bez wcześniejszego uprzedzenia.
Cennik nie jest ofertą w rozumieniu prawa.

Cargo Box Pool	G2L (6x6 models only)	715005256	1 776,00 zł
	<ul style="list-style-type: none"> • Transforms the flatbed into a large capacity cargo box for increased loading possibilities. • Made of durable formed HDPE and shaped to maximize cargo space. • Allows access to vehicle's water-resistant rear compartment. • Designed for perfect fit and easy installation. 		
Tarpaulin	G2 (6x6 models only)	715002416	1 926,00 zł
	<ul style="list-style-type: none"> • Fitted to cover all of the items in your cargo box thoroughly. • Prevents splash from entering cargo box. • Easily removable for quick access. 		
18 Gal (70 L) Utility Box	G2 (6x6 models only)	715001999	2 538,00 zł
	<ul style="list-style-type: none"> • Wherever you go and whatever you do, this handy 18 gal (70 L) utility box is your mobile storage. • The lid keeps your equipment safe from the elements in all conditions. • Slides under the flatbed with handles for easy access. 		
Cargo Box Net	G2 (6x6 models only)	715001371	324,00 zł
	<ul style="list-style-type: none"> • Solid net designed to hook to the bottom of the cargo box for secure and compact confinement of your cargo. 		
Soft Storage Bag	G2, G2L, G2S	715003759	816,00 zł
	<ul style="list-style-type: none"> • 3 -section bag. • Transport gear in a weatherproof bag. • 11.8 gal (45 L) capacity soft cargo bag designed with vehicle's rack in mind to maximize potential storage. • LinQ Luggage Rack (715001734) is required for G2S. 		
Storage 2.6 Gal (10 L) Bag		269502121	172,00 zł
	<ul style="list-style-type: none"> • Roll-top dry bag for fully protecting your cargo from the elements. • Fits in rear compartment of your vehicle. 		

Cennik zawiera sugerowane ceny detaliczne brutto w walucie PLN. Ceny mogą ulec zmianie bez wcześniejszego uprzedzenia.
Cennik nie jest ofertą w rozumieniu prawa.

CAN-AM WINDSHIELDS

Deluxe Fairing	G2 (except X mr & 6x6), G2L	<ul style="list-style-type: none"> ■ 715001232 · Black ■ 715000935 · Yellow 2000 ■ 715002479 · Light Gray ■ 715006125 · Squadron Green ■ 715007073 · Tundra Green 	1 261,00 zł



- Innovative, richly featured wind protection.
- Quick tool-less removal once base brackets are mounted on handlebar.
- Two cup holders.
- Ready for GPS mounting kit.
- Optional mirrors and auxiliary lighting.
- Requires low, high or extra high windshield.
- Tapered Handlebar Adapter Kit is required for vehicles with 1½" (28 mm) tapered aluminum handlebars.
- Does not fit T3 models.

Tapered Handlebar Adapter Kit <i>(Not illustrated)</i>	Deluxe Fairing	715002470	173,00 zł
<ul style="list-style-type: none"> • Required to install Deluxe Fairing on an Outlander X-TP and on any vehicle equipped with 1½" (28 mm) tapered aluminum handlebars. 			

Extra High Windshield	Deluxe Fairing	715000936	636,00 zł
------------------------------	----------------	------------------	-----------



- 16" (41 cm) windshield provides the ultimate protection against the elements while touring.
 - For wind protection and winter applications.
 - Tool-less installation and replacement.
- Installation of some accessories shown may impact vehicle compliance with some regulations. Consult your local dealer for information.*

High Windshield	Deluxe Fairing	715001211	423,00 zł
------------------------	----------------	------------------	-----------



- 11" (28 cm) high, for wind protection and winter applications.
 - Tool-less installation and replacement.
- Installation of some accessories shown may impact vehicle compliance with some regulations. Consult your local dealer for information.*

Low Windshield	Deluxe Fairing	715001227	394,00 zł
-----------------------	----------------	------------------	-----------



- 6" (15 cm) windshield allows you to keep your vehicle looking sporty while giving you some protection from the elements and the possibility of enjoying directional lighting.
 - Tool-less installation and replacement.
- Installation of some accessories shown may impact vehicle compliance with some regulations. Consult your local dealer for information.*

Accessories

Auxiliary Windshield Lighting	Deluxe Fairing	715003115	2 186,00 zł
--------------------------------------	----------------	------------------	-------------



- 2 premium LED spots for Deluxe Fairing for both increased output and directional lighting.
- 1,800 lumens.
- 2 x 10 W LED Cree light kit.
- Long-range illumination up to 350' (107 m), drawing less than 1 amp per light.

Deluxe Mirror Kit	Deluxe Fairing	715002353	353,00 zł
--------------------------	----------------	------------------	-----------



- Improved mounting system.
- Wide rear view.
- Perfect fit with your Deluxe Fairing.

Cennik zawiera sugerowane ceny detaliczne brutto w walucie PLN. Ceny mogą ulec zmianie bez wcześniejszego uprzedzenia.
Cennik nie jest ofertą w rozumieniu prawa.

Windshield Kits

Extra High Windshield Kit | G2, G2L, G2S (except X mr models) | **715003023** | 1 469,00 zł



- Made of polycarbonate with integrated vent to reduce air turbulence and rumble noise at high speeds for a quieter and smoother ride.
- Quick tool-less removal once base brackets are mounted on handlebar.
- Fits straight and tapered handlebars.
- Improved design for enhanced rigidity.
- Steering Cover (709400939) is required for XT and Mossy Oak models.
- 16" (41 cm) windshield.
- For ultimate wind protection and winter applications.

Installation of some accessories shown may impact vehicle compliance with some regulations. Consult your local dealer for information.

High Windshield Kit | G2, G2L, G2S (except X mr models) | **715006382** | 1 272,00 zł



- Made of polycarbonate with integrated vent to reduce air turbulence and rumble noise at high speeds for a quieter and smoother ride.
- Quick tool-less removal once base brackets are mounted on handlebar.
- Fits straight and tapered handlebars.
- Improved design for enhanced rigidity.
- Steering Cover (709400939) is required for XT and Mossy Oak models.
- 11" (28 cm) windshield.
- For wind protection and winter applications.

Installation of some accessories shown may impact vehicle compliance with some regulations. Consult your local dealer for information.

Low Windshield Kit | G2, G2L, G2S (except X mr models) | **715003021** | 1 076,00 zł



- Made of polycarbonate with integrated vent to reduce air turbulence and rumble noise at high speeds for a quieter and smoother ride.
- Quick tool-less removal once base brackets are mounted on handlebar.
- Fits straight and tapered handlebars.
- Improved design for enhanced rigidity.
- Steering Cover (709400939) is required for XT and Mossy Oak models.
- 6" (15 cm) windshield.
- Allows you to keep your vehicle looking sporty while giving you some protection from the elements.

Installation of some accessories shown may impact vehicle compliance with some regulations. Consult your local dealer for information.

HANDLEBARS & MIRRORS

Handlebar Wind Deflectors | G2, G2L, G2S



- Rugged injected plastic construction with Can-Am logo.
- Include removable cap for air flow adjustment.
- Mounting kit sold separately.

- | | | | |
|--|-----------|---|-----------|
| ■ 715000525 · Black / Yellow | 147,00 zł | ■ 715003813 · Orange / Black | 147,00 zł |
| ■ 715000537 · White / Black | | ■ 715003814 · Octane Blue / Black | |
| ■ 715001706 · Black / Black | | ■ 715006117 · Squadron Green / Black | |
| ■ 715003811 · Can-Am Red / Black | | ■ 715006118 · Viper Red / Black | |
| ■ 715003812 · Manta Green / Black | | | |

Passenger Wind Deflectors | G2 and G2L (MAX models only) | **715001669** | 457,00 zł



- These wind deflectors fit on the passenger handles and provide greater comfort while riding.
- Easy to install and remove.

Full Wrap Aluminum Mounting Kit | G2, G2L, G2S | **715001378** | 636,00 zł



- Lightweight black die cast aluminum construction.
- Includes complete hardware.
- Handlebar wind deflectors sold separately.

Aluminum Tapered Handlebar | G2, G2L, G2S | **715000550** | 585,00 zł



- 7/8" - 1 1/8" (22 mm - 28 mm) tapered handlebar made of 6061-T6 aluminum.
- Includes all hardware, center steering foam and cover.

Cennik zawiera sugerowane ceny detaliczne brutto w walucie PLN. Ceny mogą ulec zmianie bez wcześniejszego uprzedzenia.

Cennik nie jest ofertą w rozumieniu prawa.

Mirrors Left – ¾" (10 mm)	G2, G2L, G2S	708200963	155,00 zł
----------------------------------	--------------	------------------	-----------



- Adjustable handlebar mounted convex mirrors.
- The convex surface allows improved visibility with a wider field of view.
- Matte finish.
- Stem includes ¾" (10 mm) thread.
- Bracket (715000190) is required for installation on DS 450.
- Bracket not required for installation on Outlander and Renegade.

Mirrors Right – ¾" (10 mm) <i>(Not illustrated)</i>	G2, G2L, G2S	709400523	161,00 zł
---	--------------	------------------	-----------

- True vision surface 5" x 3" (13 cm x 8 cm).
- Matte finish.
- Stem includes ¾" (10 mm) thread.
- Bracket (715000190) required except for vehicles with right hand brake.

Handlebar Mirrors	G2, G2L, G2S	715005366	343,00 zł
--------------------------	--------------	------------------	-----------



- Adjustable handlebar mounted convex mirrors.
- The convex surface allows improved visibility with a wider field of view.
- Doesn't require a windshield or fairing to be mounted.
- Works with all windshield options.

SEATS

Driver Backrest	G2L (except MAX models)	715003941	1 284,00 zł
------------------------	-------------------------	------------------	-------------



- Provides the rider's back with that extra support that makes riding that extra mile way more comfortable.
- Adjusts horizontally to match the driver's height and preference.
- Mounts and locks firmly onto the vehicle.

Outlander Max Passenger Seat Kit	G2 2015 & up, G2L (MAX models only)	715002373	3 417,00 zł
---	-------------------------------------	------------------	-------------



- Perfect to replace used or damaged passenger seat.

Heavy-Duty Seat Cover	G2, G2L	715007212	271,00 zł
------------------------------	---------	------------------	-----------



- Heavy-duty materials to cover and protect the seat.
- Abrasion- and tear-resistant.
- Simply installs by stretching around the original seat; the elastic holds the cover securely in place.

Cennik zawiera sugerowane ceny detaliczne brutto w walucie PLN. Ceny mogą ulec zmianie bez wcześniejszego uprzedzenia.
Cennik nie jest ofertą w rozumieniu prawa.

HMWPE SKID PLATES

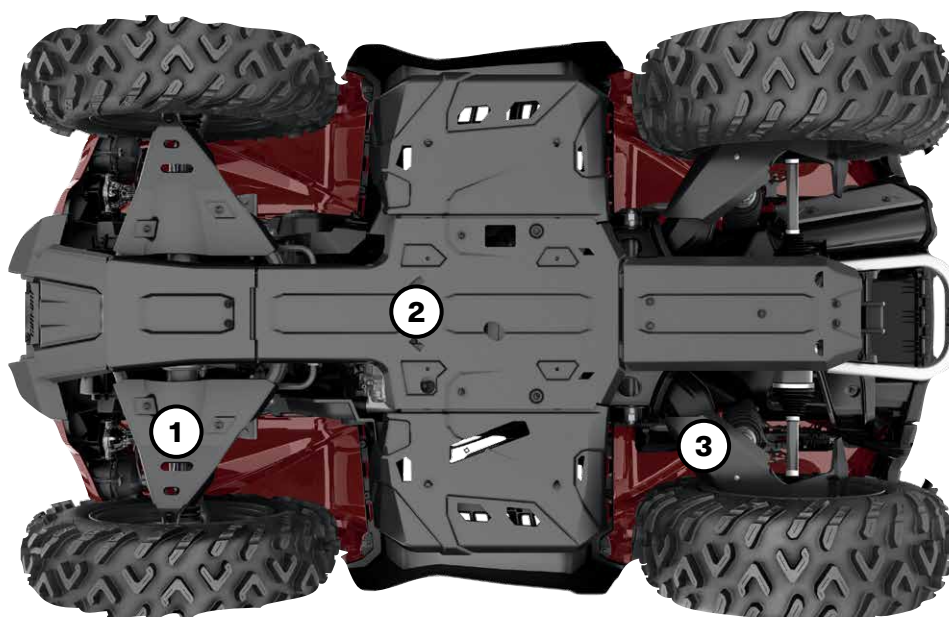

Our plastic plates glide smoothly and silently over obstacles, offering great protection in rough terrain. Made of ¼" (6 mm) thick abrasion-resistant thermoformed High Molecular Weight Polyethylene (HMWPE).

- Lighter than aluminum.
- Superior stress crack resistance.
- High impact strength.

OUTLANDER, RENEGADE

G2		G2L		G2S			
2016 & Prior		2017-2018		2019 & Up		2017-2018	2019-2022
Except MAX & X mr 1000R models	MAX & X mr 1000R models only	Except Max & X mr 1000R models	MAX & X mr 1000R models only	Except MAX & X mr 1000R models	MAX & X mr 1000R models only	Except MAX models	MAX models only

HMWPE Skid Plate Protection Kit

715004214	715004215	715004209	715004210	715004806	715004807	715004211	715004212	715004213	715004809
-----------	-----------	-----------	-----------	-----------	-----------	-----------	-----------	-----------	-----------

Individual HMWPE Skid Plates

① A-Arm Protectors	715002924	715002924	715002924	715002924	715004822	715004822	715002924	715002924	715002924	715004822
② Underbelly Plates <i>Footwell portion not compatible with Renegade X mr</i>	715002926	715002927	715002926	715002927	715002926	715002927	715002928	715002929	715002974	715002974
③ Trailing Arm Protectors	-	-	715003466	715003466	715004823	715004823	715003466 (2015 to 2020 models only)	715003466 (2015 to 2020 models only)	715003466	715004823

Cennik zawiera sugerowane ceny detaliczne brutto w walucie PLN. Ceny mogą ulec zmianie bez wcześniejszego uprzedzenia. Cennik nie jest ofertą w rozumieniu prawa.

PLASTIC SKID PLATES

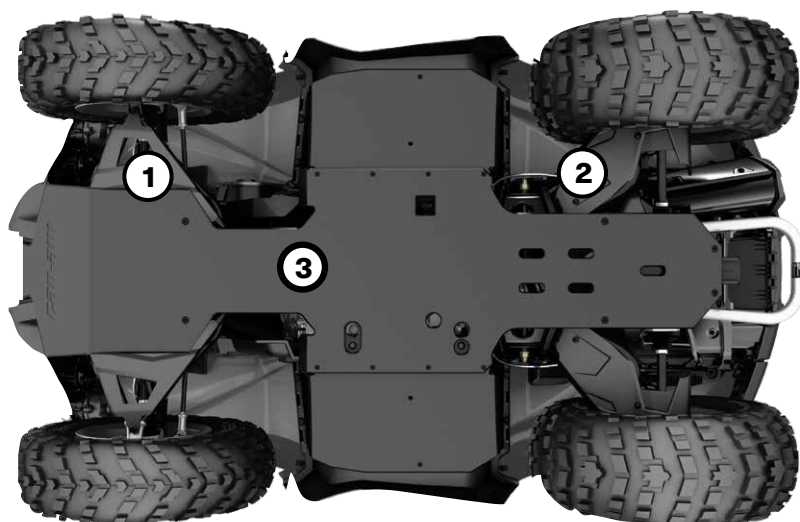

715003046

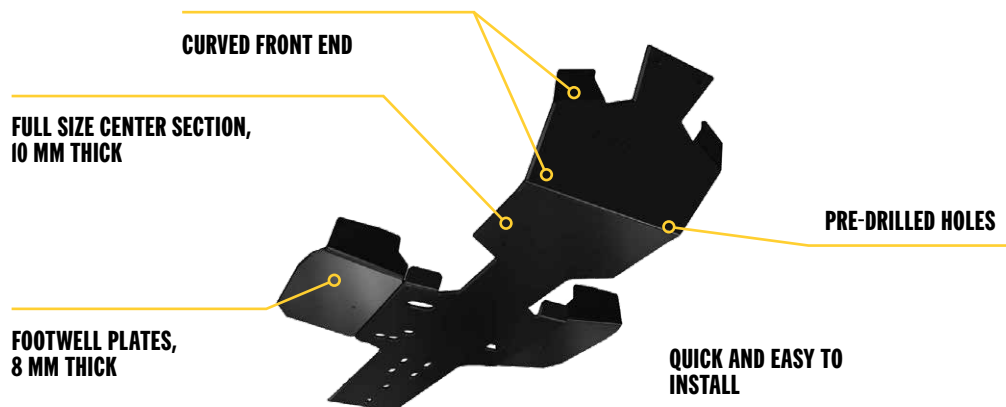

Our Plastic Plates glide smoothly and silently over obstacles, offering great protection in rough terrain. Made of abrasion-resistant thermoformed High Molecular Weight Polyethylene (HMWPE).

• Lighter than aluminum.

Offer your Outlander & Renegade the full protection kit or get them individually	OUTLANDER	OUTLANDER MAX	OUTLANDER 6X6	G2, G2S	G2L	G2L MAX
INDIVIDUAL PLASTIC SKID PLATES						
① A-ARM PROTECTORS G2	715002924	715002924	715002924	715002924	—	—
② TRAILING ARM PROTECTORS G2	715002925	—	715002925	715002925	—	—
③ PLASTIC SKID PLATE G2	715006019	715006020	715005290 715005320 (MAX)	—	715006115	715006116

Cennik zawiera sugerowane ceny detaliczne brutto w walucie PLN. Ceny mogą ulec zmianie bez wcześniejszego uprzedzenia.
Cennik nie jest ofertą w rozumieniu prawa.

ALUMINUM SKID PLATES



For ultimate durability and strength, all our Aluminum Skid Plates are made with $\frac{3}{16}$ " (4.5 mm) thick High Strength 5052 H32 Aluminum.

- Ultimate durability.
- High strength.

OUTLANDER

		G2				G2L			
		2016 & prior		2017-2018		2019 & Up		Any year	
		Except MAX & X mr 1000R models	MAX & X mr 1000R models only	Except MAX & X mr 1000R models	MAX & X mr 1000R models only	Except MAX & X mr 1000R models	MAX & X mr 1000R models only	Except MAX models	MAX models only
Aluminum Skid Plate Protection Kit									
		715002137	715002138	715004197	715004198	715004804	715004805	715004199	715004200
Individual Aluminum Skid Plates									
①	A-Arm Protectors	715001667	715001667	715001667	715001667	715004820	715004820	715001667	715001667
②	Front Skid Plate	715000926	715000926	715000926	715000926	715000926	715000926	715001906	715001906
③	Central Skid Plate	715002078	715002078	715002078	715002078	715002078	715002078	715002078	715002078
④	Footwell Protector Plates	715000922	715000922	715000922	715000922	715000922 (except X mr 850 models)	715000922	715000922	715000922
⑤	Trailing Arm Protectors	—	—	715008595	715008595	715004821	715004821	715008595	715008595
⑥	Rear Differential Protectors	715000920	715000920	715000920	715000920	715000920	715000920	715000920	715000920
⑦	Rear Skid Plate	715002028	715002029	715002028	715002029	715002028	715002029	715002028	715002029

Cennik zawiera sugerowane ceny detaliczne brutto w walucie PLN. Ceny mogą ulec zmianie bez wcześniejszego uprzedzenia.
Cennik nie jest ofertą w rozumieniu prawa.

ALUMINUM SKID PLATES



For ultimate durability and strength, all our Aluminum Skid Plates are made with 3/16" (4.5 mm) thick High Strength 5052 H32 Aluminum.

- Ultimate durability.
- High strength.

RENEGADE

G2S

	2016 & prior	2017-2018	2019-2022	2023 & up
Individual Aluminum Skid Plates				
① A-Arm Protectors	715001667	715001667	715004820	715004820
② Front Skid Plate	715000925	715000925	715000925	715001906
③ Central Skid Plate	715002078	715002078	715002078	715002078
④ Trailing Arm Protectors	715001129	715008595	715004821	715004821
⑤ Rear Differential Protectors	715000920	715000920	715000920	715000920
⑥ Rear Skid Plate	715002028	715002028	715002028	715002028

Cennik zawiera sugerowane ceny detaliczne brutto w walucie PLN. Ceny mogą ulec zmianie bez wcześniejszego uprzedzenia.
Cennik nie jest ofertą w rozumieniu prawa.

HMWPE & ALUMINUM SKID PLATES

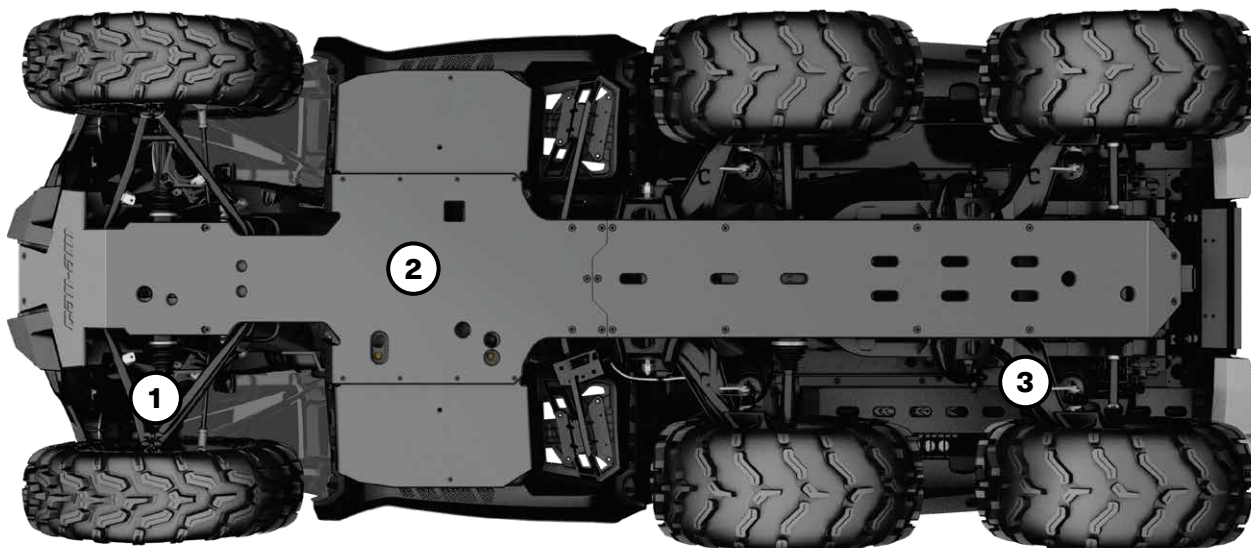

Our Plastic and Aluminum Plates glide smoothly and silently over obstacles, offering great protection in rough terrain.

HMWPE

Made of ¼" (6 mm) thick abrasion resistant thermoformed High Molecular Weight Polyethylene (HMWPE).

- Lighter than aluminum.
- Superior stress crack resistance.
- High impact strength.

ALUMINUM

Made with High Strength ¾" (4.5 mm) thick 5052 H32 Aluminum.

- Ultimate durability.
- High strength.







OUTLANDER 6X6

	G2 6x6			G2L 6x6
	2016 & prior	2017 - 2018	2019 & up	Any year
Individual HMWPE Skid Plates				
① HMWPE A-Arm Protectors	715002924	715002924	715004822	715002924
② HDPE Full Underbelly Skid Plate	715005290 (except Max)	715005290	715005290 (except Max)	715004987 (except MAX)
	715005320 (MAX only)	715005320	715005320 (MAX only)	715005259 (MAX only)
③ HMWPE Trailing Arm Protectors	-	715003466	715004823	715003466 (2020 models & prior only)
Individual Aluminum Skid Plates				
① Aluminum A-Arm Protectors	715001667	715001667	715004820	715001667
② Aluminum Full Underbelly Skid Plate	-	-	-	-
③ Aluminum Trailing Arm Protectors	-	715008595	715004821	715008595

Cennik zawiera sugerowane ceny detaliczne brutto w walucie PLN. Ceny mogą ulec zmianie bez wcześniejszego uprzedzenia.
Cennik nie jest ofertą w rozumieniu prawa.

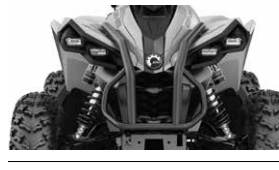
BUMPERS & GUARDS

Bumpers

Expedition Front Bumper	G2, G2L (except X mr models & X xc models 2022 & up)	715007233	1 469,00 zł
	<ul style="list-style-type: none"> • Made of 1.5" profiled steel tubes for complete protection of the vehicle's front. • Protects and doesn't obstruct the vehicle's headlights. • Integrated mounting spots for lights. • Inside and outside anticorrosion coating with a durable powder coat finish. 		
Expedition Rear Bumper	G2, G2L	715007234	1 319,00 zł
	<ul style="list-style-type: none"> • Made of 1.5" profiled steel tubes for complete protection of the vehicle's rear. • Protects and doesn't obstruct the vehicle's taillights. • Inside and outside anticorrosion coating with a durable powder coat finish. • G2 base and DPS rear bumper installation requires 705008164 and 705008165. 		
X mr Front Bumper	G2S 2023 & up	715008198	1 423,00 zł
	<ul style="list-style-type: none"> • Enhanced vehicle front protection. Required as a mounting point for Radiator Relocator (715008898). 		
XT Front Bumper	G2	715004837	1 035,00 zł
	<ul style="list-style-type: none"> • Provides additional protection against obstacles. • Tough and durable, can be added on base Outlander model to convert vehicle into XT model. • Standard on XT, XT-P, Mossy Oak and Limited models. • Large tube construction with textured black finish and metal corners. 		
XT Rear Bumper	G2	715004920	1 035,00 zł
	<ul style="list-style-type: none"> • Provides additional protection against obstacles. • Tough and durable, can be added on base Outlander model to convert vehicle into XT model. • Standard on XT, XT-P, Mossy Oak and Limited models. • Large tube construction with textured black finish and metal corners. 		
XT Front Bumper	G2L	715001910	769,00 zł
	<ul style="list-style-type: none"> • Winch compatible. • Large tube construction. • Protects vehicle against obstacles. • Standard on XT models. 		
XT Rear Bumper	G2L	715001911	608,00 zł
	<ul style="list-style-type: none"> • Large tube construction. • Protects vehicle against obstacles. • Standard on XT models. 		

Cennik zawiera sugerowane ceny detaliczne brutto w walucie PLN. Ceny mogą ulec zmianie bez wcześniejszego uprzedzenia.
Cennik nie jest ofertą w rozumieniu prawa.

Extreme Front Bumper	G2	715001286*	1 492,00 zł
	G2L	715004279	1 377,00 zł



- Ultra-sturdy build.
- Enhances front-vehicle protection.
- Compatible with XT Front Bumper.
- Fits the Apache™ 360 Track System (when side panels are removed).

*Not compatible with Front Hitch.

Installation of some accessories shown may impact vehicle compliance with some regulations. Consult your local dealer for information.

Rancher Front Bumper	G2, G2L (except X mr models)	715003461	1 666,00 zł
-----------------------------	------------------------------	------------------	-------------



- The low front end protection and plates allow you to use your ATV within cattle herds and guard the safety of both the vehicle and the animals.
- The flat front portion facilitates gently prodding cattle or pushing light objects, e.g., closing a fence.
- The full frontage coverage extends to provide an extra layer of defense to your headlights and radiator.
- Inside and outside anti-corrosion coating with durable powder coat finish.
- Not compatible with track systems, plows and front hitch.

Installation of some accessories shown may impact vehicle compliance with some regulations. Consult your local dealer for information.

Rancher Rear Bumper	G2, G2L (except 6x6 models)	715003462	1 411,00 zł
----------------------------	-----------------------------	------------------	-------------



- Ideal for using your ATV within cattle herds and guarding the safety of both the vehicle and the animals.
- Coverage extends to provide an extra layer of defense to your taillights.
- Inside and outside anti-corrosion coating with durable powder coat finish.
- Not compatible with track systems.

Installation of some accessories shown may impact vehicle compliance with some regulations. Consult your local dealer for information.

Renegade Extreme Front Bumper	G2S 2022 and prior (except X mr models)	715002469	1 319,00 zł
--------------------------------------	---	------------------	-------------



- Enhanced vehicle front protection.
- Required as a mounting point for Radiator Relocator (715008898).

Guards

Body Side Protector	G2 2012 to 2018 with stock XT Bumper, G2 2012 & up with Rancher Bumper, G2L with Rancher Bumper, (except X mr and 6x6 models)	715003459	1 810,00 zł
	G2 2019 & up with XT Bumpers, (except X mr and 6x6 models)	715004940*	1 868,00 zł



- The heavy-duty fender guard designed to pull double duty, protecting your ATV and also enhancing the look of your ATV.
- Made tough and designed to deliver a rugged appearance, this fender guard offers full side protection for farmer, rancher and forestry applications.
- Durable and bold 1.25" (3 cm) diameter steel-tube construction, with inside and outside anti-corrosion coating with durable powder coat finish.
- Not compatible with Self Clearing Footwell.
- XT Front and Rear Bumpers or Rancher Front and Rear Bumpers are required for installation.
- Requires Body Side Protector Extensions (715003460) for installation on MAX models.

*Not compatible with Front and Rear Rancher Bumpers.

Body Side Protector Extensions (Not illustrated)	G2, G2L (MAX models only)	715003460	359,00 zł
--	---------------------------	------------------	-----------

- This specially designed extension for the Body Side Protector is made specifically to fit and seamlessly integrate into the look of Outlander MAX models.

Mud Flaps	G2 (with stock fender flares)	715007089	286,00 zł
------------------	-------------------------------	------------------	-----------



- Keep mud, snow and debris out of cargo area and protect trailer and vehicles behind you.
- Add aesthetic appearance to your vehicle.
- Require stock fender flare.
- Sold in pairs.

Cennik zawiera sugerowane ceny detaliczne brutto w walucie PLN. Ceny mogą ulec zmianie bez wcześniejszego uprzedzenia.
Cennik nie jest ofertą w rozumieniu prawa.

Fender Flares	G2 2012-2018 (except with 30" tires) (except 6x6 models)	715001764*	718,00 zł
	G2 2019 & up (with 30" tires) (except 6x6 models)	715004250**	718,00 zł
	G2L	715001909***	718,00 zł
	G2L European vehicles only 2015 & up	715004487	776,00 zł



- Kit designed to deliver extra protection from dirt and debris, therefore a must if you enjoy riding in the mud.
- Made of injected plastic that hugs your vehicle fenders perfectly.
- Gives vehicle added flair for that rugged cool look.
- Includes front and rear extensions and all mounting hardware.

*Comes stock on G2 models 2019 & up (except X mr models).

**Standard on G2 X mr 1000R.

***Not compatible with European vehicles.

Fender Flare Extensions	G2 (except 6x6 models)	715005111*	1 209,00 zł
--------------------------------	------------------------	-------------------	-------------



- Block terrain debris from kicking up onto you as you ride or damaging your vehicle thanks to these extra-large Fender Flare Extensions, which also include mud flaps for added protection from mud/snow, especially when riding with track kits.
- Made of High Molecular Weight Polyethylene (HMWPE) for advanced abrasion resistance.
- Include front and rear extensions.

*Must be used with Fender Flare for G2 (715001764).

Fender Flares	G2S (except X mr models)	705012695	1 458,00 zł
----------------------	--------------------------	------------------	-------------



- Integrated extended Fender Flares for sporty look and full body protection from dirt and water.
- Include front and rear extensions and all mounting hardware.

Flatbed Protection Tubes	G2 (6x6 models only)	715002030	2 527,00 zł
---------------------------------	----------------------	------------------	-------------



- Bolt-on bumpers for the sides of the 6x6 flatbed.
- Protect the exterior plastic components of the flatbed from rocks, trees and other obstacles when traversing enclosed areas or loading cargo onto the bed.

Flatbed Protection Tubes	G2L (6x6 models only)	715005266	1 764,00 zł
---------------------------------	-----------------------	------------------	-------------



- Bolt-on bumpers for the sides of the 6x6 flatbed.
- Protect the exterior plastic components of the flatbed from rocks, trees and other obstacles when traversing enclosed areas or loading cargo onto the bed.

LIGHTS & ELECTRICAL

Integrated Heated Grips & Thumb Throttle Combo	G2, G2L, G2S (2024 & up)	715005072	1 585,00 zł
---	--------------------------	------------------	-------------



- Heat levels for grips and thumb displayed on vehicle screen.
- Ergonomic button integrated on LH grip.
- Single button for both grips and thumb heat selection.
- Five temperature settings for the thumb and grips.
- Adjustable heat ratio between grip and thumb warmer.
- Hold button to reach maximum heat quickly.
- Remembers your last heat setting.
- IP67-rated waterproof sealing keeps the elements out.
- ECE compliant.
- Plug-and-play installation.
- Clamp-on grips, no glue required.

Heated Grips & Thumb Throttle Combo	G2, G2L, G2S	715003250 Not compatible with Intelligent Throttle Control (iTC)	1 481,00 zł
	G2, G2L, G2S	715008739* Compatible with Intelligent Throttle Control (iTC)	1 481,00 zł



- LED dimmer facilitates reading temperature settings.
- 4 temperature settings with individual controls for thumb and grips.
- Returns to previous heat setting.
- One-touch shutdown.
- Wiring Cable is required for installation on G2L models only.









*Relocation bracket 715007619 required for installation on T-category models & G2L XU (INTL)

Cennik zawiera sugerowane ceny detaliczne brutto w walucie PLN. Ceny mogą ulec zmianie bez wcześniejszego uprzedzenia.
Cennik nie jest ofertą w rozumieniu prawa.

Wiring Cable <i>(Not illustrated)</i>	G2L	710004567	58,00 zł
<ul style="list-style-type: none"> Required for installation of Heated Hand Grips and Throttle Combo. 			
Heated Visor Outlet	G2, G2L	715001246	301,00 zł
	<ul style="list-style-type: none"> Strategically positioned on vehicle to maintain your agility. Optional visor outlet that delivers fog-free riding. Quick and easy installation. Sold individually. Heated Visor not included. 		
Heated Passenger Grips & Visor Outlet	G2, G2L (MAX models only)	715008794	1 255,00 zł
	<ul style="list-style-type: none"> Replace your stock passenger handles. Dual temperature switch integrated into seat arm for 3-zone heated handles and grips. Heated visor outlet integrated into seat arm. 		
USB Power Outlet Kit	G2, G2L, G2S	219400510	211,00 zł
	<ul style="list-style-type: none"> Recharges your electronic devices while riding* (smartphone, MP3, heating gear, etc.). Dual port USB connectors. The power outlet is not capable of recharging all device types while riding. 		
Seat Heater	G2, G2L	715007211	712,00 zł
	<ul style="list-style-type: none"> 25 W seat heater delivers chill-free riding comfort. One temperature only. Heated pad and electrical harness only. Heavy Duty Seat Cover (715007212) is required for the installation. 		
Bluetooth Handlebar Soundbar by MTX	G2, G2L, G2S	219400840	2 579,00 zł
	<ul style="list-style-type: none"> Bluetooth speaker with the unbeatable convenience of fingertip control. Rugged IP66-rated weather-resistant speaker designed for outdoor use. Driven by 150 watts of quality audio power. Seamless integration and operation from Bluetooth enabled devices. <ul style="list-style-type: none"> Includes input, ground and ignition wires, plus auxiliary port and 3.5" (8.89 cm) connector cable. Not compatible with XT Handlebar Protector Kit. EC compliant. <p><i>Note: We recommend you use 320 kbps MP3, 192-256 kbps AAC or AIFF, WAV formats to match the potential of the speaker. More compressed formats will probably have degraded sound quality.</i></p>		
Electronic Device Holder	G2, G2L (except 6x6 & X mr models)	715004919	712,00 zł
	<ul style="list-style-type: none"> Robust injected-polypropylene construction allows for the right fit and easy installation. Adjustable unit safely holds smartphones or small tablets with a length or width measuring between 2.9" (7.5 cm) and 5.1" (13.0 cm) with or without protective case. Integrated storage (0.6 gal / 2.1 L). <ul style="list-style-type: none"> Guiding wire grooves to pass charging cable through the lid. Possibility of relocating 12V power outlet or installing USB outlet in storage compartment (USB power outlet sold separately). Not compatible with windshields or Snorkel Kit. 		
Engine heater	Outlander 500 / 570 / 650 / 800 (G1/G2)	605154278	1 157,00 zł
	Outlander 1000 (G2)	715002043	1 209,00 zł
3.5" (9 cm) LED Lights (2 X 14 W) LED Driving Lights	G2, G2L (except X mr models)	715009775	1 190,00 zł
	<ul style="list-style-type: none"> 14 W LED lights producing 1,260 lumens each. Equipped with 6 high power LEDs in a heavy-duty die cast aluminum housing. Features 2 attachment points — if one attachment point fails due to a collision, rotate to the next channel point and re-mount the light. <ul style="list-style-type: none"> Sold in pairs. ECE certified. Spot lens for a narrow and long light beam spread, ideal when driving at higher speeds. Expedition Front Bumper (715007233) and Light Power Cable (715007275) required for installation. 		
3.5" (9 cm) LED Flood Lights (2 X 14 W)	G2, G2L (except X mr models)	715009774	1 190,00 zł
	<ul style="list-style-type: none"> 14 W LED lights producing 1,260 lumens each. Equipped with 6 high power LEDs in a heavy-duty die cast aluminum housing. Features 2 attachment points — if one attachment point fails due to a collision, rotate to the next channel point and re-mount the light. <ul style="list-style-type: none"> Sold in pairs. ECE certified. Flood lens for a wide light beam spread, ideal for working applications like plowing or for winding, dusty or foggy riding conditions. Expedition Front Bumper (715007233) and Light Power Cable (715007275) required for installation. 		

Cennik zawiera sugerowane ceny detaliczne brutto w walucie PLN. Ceny mogą ulec zmianie bez wcześniejszego uprzedzenia.

Cennik nie jest ofertą w rozumieniu prawa.

4" (10 cm) Round LED Lights (2 x 25 W)	G2, G2L (except X mr models)	715002935	2 035,00 zł
	<ul style="list-style-type: none"> • 25 W LED spotlights. • 1,800 lumens. • Rugged and waterproof. • Includes basic wiring and switch. • Can-Am branded grill. • Sold in pairs. • Not EC compliant. • Expedition Front Bumper (715007233) and Light Power Cable (715007275) required for installation. 		
10" (25 cm) Double Stacked LED Light Bar (60 W)	G2, G2L (except X mr models)	715002933	1 659,00 zł
	<ul style="list-style-type: none"> • Equipped with twelve 5 W Cree LEDs. • 5,400 lumens. • Packs a big punch for its size. • Rugged and waterproof. • Can be installed on front bumpers, sport roof and Bimini roof with sun visor. • Expedition Front Bumpers (715007233) and Light Power Cable (715007275) required for installation. • Lights up to more than 1,500 ft (460 m) in front of the vehicle and around 65 ft (20 m) wide on each side. • ECE certified. 		
Light Power Cable <i>(Not illustrated)</i>	G2, G2L	715007275	636,00 zł
<ul style="list-style-type: none"> • Required for installation of the 10" (25 cm) LED Light Bar, the 3.5" (9 cm) and 4" (10 cm) LED Lights. 			
Baja Designs High Beam Kit	G2 (2022 and prior)	715004284	3 643,00 zł
	<ul style="list-style-type: none"> • Thanks to their direct bolt-on and plug-and-play installation right into the original high beam location, upgrading from your stock high beam lights to these powerful Baja Designs Squadron Pro LED Lights becomes child's play. • Each spot is equipped with 4 Cree LEDs producing 4,900 lumens at 40 watts. • Driving/Combo light pattern for smooth blend of light for both near field applications and distance. • Not EC compliant 		
2" (5 cm) Square LED Lights (2 X 10 W)	G2, G2L, G2S	715004293	938,00 zł
	<ul style="list-style-type: none"> • 2 x 900 lumens 10 W LED Cree light kit. • Long-range illumination up to 350' (107 m), drawing less than 1 amp per light. • Multi-Position Light Mount Kit is required for installation. • Not EC compliant. 		
Multi Position Light Mount Kit	G2, G2L, G2S	715004274	510,00 zł
	<ul style="list-style-type: none"> • Multi-position plastic clamps that fit on various tubing sizes: 0.75" to 1.5" (19 mm to 38 mm). • Required for the installation of the 2" (5 cm) Square LED Lights (2 x 10 W). • Kit includes tube clamp mounts and power cables. 		
RAM⁺ LED Spotlight	G2, G2L, G2S	710005423	777,00 zł
	<ul style="list-style-type: none"> • 540-lumen LED light (9 W) heavy-duty spotlight standard-equipped with 1" (2.5 cm) diameter rubber-coated double ball and socket system. <p><i>Installation of some accessories shown may impact vehicle compliance with some regulations. Consult your local dealer for information.</i></p>		
C-TEK charger	860200997 567,00 zł		
	<ul style="list-style-type: none"> • CTEK, the manufacturer of the smartest battery chargers in the world, has produced a BRP specific charger for all BRP products. • Charger is built to meet the demanding arctic conditions. • Ask your dealer for more information. 		
GPS RAM⁺ Mount for Handlebar	G2, G2L, G2S	715001985	371,00 zł
	<ul style="list-style-type: none"> • Convenient bracket for installing the Garmin Montana GPS (not included) onto your unit's handlebar. 		

Cennik zawiera sugerowane ceny detaliczne brutto w walucie PLN. Ceny mogą ulec zmianie bez wcześniejszego uprzedzenia.
Cennik nie jest ofertą w rozumieniu prawa.

Digitally Encoded Security System (D.E.S.S.™) Green Key

G2, G2S (2018 & up)

710005232

322,00 zł



- Anti-theft technology, Digitally Encoded Security System (D.E.S.S) key snaps easily on the vehicle and provides riders easy and quick starts every time.
- The key communicates with the vehicle wirelessly so the vehicle starts only when the key code matches the vehicle, for ultimate peace of mind.
- The Programmable D.E.S.S. Key can also be programmed in 3 modes:
 - Work mode: Limits vehicle speed to 40 kph (25 mph) but does not limit engine torque.
 - Normal mode: Limits vehicle speed to 70 kph (44 mph) and 50% torque reduction.
 - Performance mode: No restrictions.

WINCHES

Can-Am HD Winches

Can-Am HD 2500 Winch

G2, G2L (except T-cat 2022 & up)

715006414

1 473,00 zł

T-cat 2022 & up and G2L XU (INT)

715008140

1 707,00 zł



- Heavy-duty four-way roller fairlead.
- Ergonomic clutch handle.
- Rugged all-steel gears and bushings provide more torque and longer life.
- Automatic 100% load-holding brake.
- Sealed solenoid for all-weather protection.
- Wired Remote Control sold separately.
- Plug-and-play wiring and attachment brackets.
- Weather-sealed handlebar-mounted switch.
- Pulling strength capability of 2,500 lb (1,134 kg).
- 50 ft. of 3/16" (15.2 m of 4.8 mm) wire steel cable.
- EC-compliant.

Can-Am HD 3500 Winch

G2, G2L (except T-cat 2022 & up)

715006415

1 645,00 zł

T-cat 2022 & up and G2L XU (INT)

715008141

1 842,00 zł



- Heavy-duty four-way roller fairlead.
- Ergonomic clutch handle.
- Rugged all-steel gears and bushings provide more torque and longer life.
- Automatic 100% load-holding brake.
- Sealed solenoid for all-weather protection.
- Wired Remote Control sold separately.
- Plug-and-play wiring and attachment brackets.
- Weather-sealed handlebar-mounted switch.
- Pulling strength capability of 3,500 lb (1,588 kg).
- 50 ft. of 7/32" (15.2 m of 5.4 mm) wire steel cable.
- EC-compliant.

Winch Accessories

Wireless Remote Control

WARN Winches

715002542

1 281,00 zł



- The system is quick and easy to install, thanks to a wiring harness with an integrated antenna and all necessary mounting hardware.
- The system allows you to operate your winch from anywhere within a 50' (15.2 m) radius, increasing your recovery options.
- All components are weatherproof.

Wired Remote Control

WARN Winches

715006378

446,00 zł

Can-Am HD Winches (715006414 & 715006415)

715006555

147,00 zł

Can-Am HD Winches (715008140, 715008141 & 715008285)

715008121

151,00 zł



- This kit allows owners to add a handheld remote to their winch or a stock winch.
- Works with the handlebar-mounted switch.
- Wired Remote and Remote Socket included.
- 10 ft. wire.

Rear winch kit

G2 (except 6x6 models)

715007100

3 008,00 zł

G2 (6x6 models only)

715006503

2 373,00 zł

G2L (6x6 models only)

715007099

2 212,00 zł



- The remote-controlled rear winch is a godsend when you want to pull yourself out of a tough spot or move heavy loads.
- Includes a fully-sealed Warn winch and all wiring and hardware needed for an easy and quick installation.
- Pulling strength capability of 3,000 lb (1,361 kg).
- 50 ft. of 7/32" (15.2 m of 5.5 mm) wire steel cable.

Cennik zawiera sugerowane ceny detaliczne brutto w walucie PLN. Ceny mogą ulec zmianie bez wcześniejszego uprzedzenia.

Cennik nie jest ofertą w rozumieniu prawa.

Winch Accessories Kit	715002409	706,00 zł
------------------------------	------------------	-----------



- Get the most out of your winch.
- Double your pulling power, change your pulling direction and keep your winch in proper working order.
- Includes tree straps, snatch block, shackle and winching gloves.

WARN Hawse Fairlead	WARN Winches	715007698	371,00 zł
----------------------------	--------------	------------------	-----------



- Double powder-coated construction.
- Required to use the Synthetic Winch.
- Cable (715004254) on WARN winches.
- To be used with synthetic winch cables only.

Roller Fairlead	WARN Winches	715007699	371,00 zł
	Can-Am HD Winch	710007459	267,00 zł



- Features top, bottom and side rollers for less cable wear and smoother operation from any direction for easier winching.

Hook with Safety Latch & Strap Kit <i>(Not illustrated)</i>	Can-Am HD Winches	705014949	106,00 zł
---	-------------------	------------------	-----------

- Heavy-duty winch-rope hook with stainless steel snap.
- Includes a nylon safety strap.

Replacement Wire Rope – Can-Am HD	705014983	98,00 zł
	705014984	188,00 zł



- Play it safe, always carry a replacement wire rope.
- 2,500 lb (1,134 kg) pulling strength with 50 ft of 3/16" (15.2 m of 4.8 mm) wire rope for 705014983.
- 3,500 lb (1,588 kg) pulling strength with 50 ft of 7/32" (15.2 m of 5.5 mm) wire rope for 705014984.

Replacement Wire Rope – ATV WARN Winches	715006256	376,00 zł
---	------------------	-----------



- Play it safe, always carry a replacement wire rope.
- 3,500 lb (1,588 kg) pulling strength.
- 50 ft. of 7/32" (15.2 m of 5.5 mm) aircraft grade steel wire.

Winch Wire Harness <i>(Not illustrated)</i>	G2 2021 & up, G2S 2021 & up and G2L	715002453	226,00 zł
---	-------------------------------------	------------------	-----------

- Required plug-and-go wiring to install WARN winch only.
- Not required for Can-Am HD winches.

Synthetic Winch Cable	ATV WARN Winches	715004254	723,00 zł
------------------------------	------------------	------------------	-----------



- Easier to manipulate than steel cable.
- Replaces the original cable on any factory installed WARN winch or sold as an accessory by BRP.
- Kit includes synthetic rope and rock guard sleeve.
- Always use with the new Hawse Fairlead (715007698).
- 50 ft. (15.2 m) of 3/16" (15.2 m of 4.8 mm) synthetic rope.
- 3,500 lb (1,588 kg) pulling strength.





Winch Mounting Plate	G2S 2022 & prior	715000927	631,00 zł
-----------------------------	------------------	------------------	-----------



- Adds functionality to your Renegade.
- Fits Can-Am winches by WARN.

Cennik zawiera sugerowane ceny detaliczne brutto w walucie PLN. Ceny mogą ulec zmianie bez wcześniejszego uprzedzenia.
Cennik nie jest ofertą w rozumieniu prawa.

HITCHES

Hitches			
Rear Hitch	G2, G2L (except 6x6 models), G2S	715001925	267,00 zł
	<ul style="list-style-type: none"> • E-coat finish. • Fixed hitch ball mounting bracket. • Provides fixed mounting point for trailer ball to provide vehicle with towing capabilities. • This hitch offers 1,300 lb (590 kg) of towing capacity. • Hitch ball not included. 		
Front and Rear Hitch Drawbar	G2, G2L, G2S	715008350	492,00 zł
	<ul style="list-style-type: none"> • Standard on 2" (5 cm) receiver hitch. • It offers 1,650 lb (750 kg) of towing capacity. • Hitch ball not included. • Forged steel. 		
Hitch Accessories			
Rear Receiver Hitch	G2S 2012 with 800R or 1000 engines G2S 2013 & up, G2L & G2	715005186	636,00 zł
	<ul style="list-style-type: none"> • E-coat finish. • Does not affect ground clearance. • Trailer ball not included. • On 4x4 use, this hitch offers 1,500 lb (680 kg) of towing capacity. • On 6x6 use, this hitch offers 1,654 lb (750 kg) of towing capacity. • Compliant with European T regulations. • Not compatible with G2L models with Rear Skid Plates. 		
Front Receiver Hitch	G2	715000921	521,00 zł
	<ul style="list-style-type: none"> • Front receiver hitch for Outlander with or without a winch. • This hitch offers 1,300 lb (590 kg) of towing capacity. • Allows you to maneuver your trailer easily in tight, confined areas. • Hitch bar sold separately. • Not compatible with Extreme Front Bumper, Rancher Bumper and ProMount Plows. 		
Rubber Receiver Plug		705204503	63,00 zł
	<ul style="list-style-type: none"> • Rubber cap for 2" (5 cm) hitch receiver. 		
Front coupling device	T3	705205025	233,00 zł
<ul style="list-style-type: none"> • Required for T3 models. 			
Multitrailer		619590024	10 059,00 zł
	<ul style="list-style-type: none"> • Bogie wheels updated to be more silent than before and now equipped with grease nipples. • Product developed for heavy-duty use. • 100% galvanized steel. • Specifications: 12 mm polywood base, strong stand, movable attachment points (4 pc), tipping bed, removable sides and 4 pc timber holder. • Underside of the bogie and frame designed to travel over stones and logs (no sharp edges). • Bed length: 182 cm • Bed width: 66 cm bottom / 95 cm top • Bed height: 60 cm • Weight: 200 kg with timber holders and sides 		

Cennik zawiera sugerowane ceny detaliczne brutto w walucie PLN. Ceny mogą ulec zmianie bez wcześniejszego uprzedzenia.

Cennik nie jest ofertą w rozumieniu prawa.

PERFORMANCE

Performance

Renegade Snorkel Kit	G2S (2021 & up)	715007083	3 163,00 zł
-----------------------------	-----------------	------------------	-------------



- Comprehensive kit.
- Extended air intakes and CVT exhaust.
- CVT outlet integrates into pod cover.
- Ideal for muddy conditions.

Installation of some accessories shown may impact vehicle compliance with some regulations. Consult your local dealer for information.

Renegade Radiator Relocator Kit	G2S (2023 & up)	715008898	2 527,00 zł
	G2S (2022 & prior)	715001929	2 452,00 zł



- Relocates radiator to top mount position.
- Prevents cooling performance loss in muddy conditions.
- Uses existing radiator.
- Includes support, hardware and hoses.
- Engineered for easy cooling system bleeding and maintenance.
- Radiator not included.
- Renegade Extreme Front Bumper (715002469) required for G2S 2022 and prior or X mr Front Bumper (715008198) required for 2023 and up for installation (except X mr).

Installation of some accessories shown may impact vehicle compliance with some regulations. Consult your local dealer for information.

Mud Strap	G2, G2L, G2S	715003053	234,00 zł
------------------	--------------	------------------	-----------



- Convenient sturdy grab-handle.
- Lets drivers redistribute their weight for improved traction in demanding conditions.

Radiator Protector	G2, G2S (except G2S with 500 engine)	715001744	359,00 zł
---------------------------	--------------------------------------	------------------	-----------

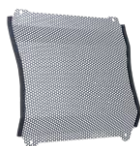

- Metal shield that mounts over radiator face, providing protection from stones and branches.

Outlander Snorkel Kit	G2 2015 & up, G2L (except X mr & 6x6 models)	715005999	2 272,00 zł
------------------------------	--	------------------	-------------



- Comprehensive kit.
- Extended air intakes and CVT exhaust.
- CVT outlet integrates into pod cover.
- Must be installed on a vehicle without XT Handlebar Protector Kit.
- Ideal for muddy conditions.
- Not compatible with windshields.

Installation of some accessories shown may impact vehicle compliance with some regulations. Consult your local dealer for information.

Outlander Snorkel Kit	G2 (X mr models only), G2L (X mr models only)	715002518	550,00 zł
------------------------------	---	------------------	-----------



- Comprehensive kit.
- Extended air intakes and CVT exhaust.
- CVT outlet integrates into pod cover.
- Must be installed on a vehicle without XT Handlebar Protector Kit.
- Ideal for muddy conditions.
- Not compatible with windshields.
- Raised horn only.
- Provides higher intake.
- For best fit and finish, appropriate gauge support is required.

Installation of some accessories shown may impact vehicle compliance with some regulations. Consult your local dealer for information.

Cennik zawiera sugerowane ceny detaliczne brutto w walucie PLN. Ceny mogą ulec zmianie bez wcześniejszego uprzedzenia.
Cennik nie jest ofertą w rozumieniu prawa.

Outlander Radiator Relocator Kit	G2, G2L (except X xc 2022 & up and 6x6 models)	715001930	2 452,00 zł
	<ul style="list-style-type: none"> Relocates radiator to top mount position. Prevents cooling performance loss in muddy conditions. Uses existing radiator. Includes support, hardware and hoses. Engineered for easy cooling system bleeding and maintenance. Radiator not included. <p><i>Installation of some accessories shown may impact vehicle compliance with some regulations. Consult your local dealer for information.</i></p>		
X mr Traction Plates	G2 (MAX models only), G2L	715001752	608,00 zł
	<ul style="list-style-type: none"> Provide extra foot grip for driver when riding in extreme mud conditions. Help driver maintain ideal riding position to maximize vehicle traction. Made of aluminum. Not meant for a passenger. 		
Self-Clearing Footwells	G2 2015 & up, G2L	715004759	1 498,00 zł
	<ul style="list-style-type: none"> Made from aluminum. Replace original footwells. Feature large evacuation ports to avoid mud and snow accumulation in footwells. Aggressive design for improved traction. Not compatible with Body Side Protectors. Sold in pairs. 		
Footpeg Kit	G2, G2L	715001131	271,00 zł
	<ul style="list-style-type: none"> Provides maximum integrated grip and more stability during vigorous riding. Kick-up end generates added grip during hard cornering. Made of aluminum. Sold in pairs. 		
Foam Air Filter by Twin Air†	G2, G2S, G2L	715001333	335,00 zł
	<ul style="list-style-type: none"> Maximizes performance by increasing air flow throughout RPM range. Maintenance-friendly, i.e., just wash, re-oil and re-use after riding in severely dusty/muddy environments. 		
Heavy-Duty Springs	G2 2012-2018 (Base model, DPS, XT, X mr with 650 engine only & Limited – except 6x6) G2S (Base model with 500 & 570 engines only) G2L (except Mossy Oak, PRO, 6x6 and X mr models) G2 2012-2018 (Base model, DPS, XT & X mr with 650 engine only – except 6x6) G2S (Base model with 500 & 570 engines only) G2 2019 & up (Base, DPS & XT models, except 6x6)	715003199 · Front 715007203 · Front 715003200 · Rear 715005159 · Front & Rear	735,00 zł 613,00 zł 735,00 zł 1 284,00 zł
	<ul style="list-style-type: none"> Heavy-duty springs provide enhanced stiffness. Perfect for snow clearing and hauling heavy loads. Improve handling. Standard on Outlander PRO and Mossy Oak models. 		
Front Shock Covers	G2, G2L, G2S	715500301	234,00 zł
	<ul style="list-style-type: none"> Feature ventilation holes. Offer added protection in rough terrain and weather conditions. Sold in pairs. 		
Front and Rear Heavy-Duty Shock kits	G2L (4x4 and 6x6 models)	715007841 · Front 715008136 · Rear	6 683,00 zł 6 672,00 zł
<ul style="list-style-type: none"> Stiffer shocks than the standard ones, for Heavy-duty usage. Improved load capacity, ground clearance and comfort (front and rear). Sold in pairs. 			
Extreme Heavy-Duty rear spring set	G2	715001998	1 423,00 zł

Cennik zawiera sugerowane ceny detaliczne brutto w walucie PLN. Ceny mogą ulec zmianie bez wcześniejszego uprzedzenia.

Cennik nie jest ofertą w rozumieniu prawa.

Yoshimura

Yoshimura Slip-On Exhaust – Outlander

G2 (except 6x6 models)

715005480



- Made from 304-grade stainless steel.
- Better sounding, better looking and lighter than stock muffler.
- USDF/USDA approved spark arrester.
- Non-EPA compliant (for racing application only).
- Not EC compliant.
- Fuel injection system tuning not required.
- Not compatible with CARB and T Category models 2018 and up, NRMM and 650 Engine 2022 and up.
- Not sold in Europe

Yoshimura Slip-On Exhaust – Renegade

G2S 2012 & up
(except 570 engine and X mr models)

715005481



- Made from 304-grade stainless steel.
- Better sounding, better looking and lighter than stock muffler.
- USDF/USDA approved spark arrester.
- Non-EPA compliant (for racing application only).
- Not EC compliant.
- Fuel injection system tuning not required.
- Not compatible with CARB and T Category models 2018 and up, NRMM and 650 Engine 2022 and up.
- Not sold in Europe

Emergency Accessories

Emergency Kit

715006102

787,00 zł



- Complete emergency kit provides all essential equipment and supplies to get out of most unfavorable situations powersport enthusiasts may find themselves in.
- Includes jumper cables, air compressor, tire-repair kit, first-aid kit, ratchet tie-down, duct tape, 3,300 lb (1,500 kg) tow strap, zip-ties and cloth rags.

COVERS, DECALS & ADD-ONS

Trailer Cover

G2 (except MAX models)

715001737

1 122,00 zł

G2 (MAX and X mr 1000R models only)

715001736

1 359,00 zł

G2L (except MAX models)

715002026

1 122,00 zł

G2L (MAX models only)

715002025

1 377,00 zł

G2S (except X mr models)

715006683

1 012,00 zł



- Heavy-duty canvas made of UV-resistant solution-dyed polyester.
- Protect windshield and colored panels from abrasion.
- All high-abrasion areas are reinforced with a double canvas layer.
- Opening for fuel cap access.
- Weather-resistant trailer cover protects your vehicle during transportation.
- Quick and easy installation.
- Designed to perfectly fit your vehicle with or without Can-Am accessories.

Heavy-Duty Seat Cover

G2, G2L

715007212

271,00 zł



- Heavy-duty materials to cover and protect the seat.
- Abrasion- and tear-resistant.
- Simply installs by stretching around the original seat; the elastic holds the cover securely in place.

Cennik zawiera sugerowane ceny detaliczne brutto w walucie PLN. Ceny mogą ulec zmianie bez wcześniejszego uprzedzenia.
Cennik nie jest ofertą w rozumieniu prawa.

	G2, G2L, G2 X mr (except 1000), G2L X mr, G2S, G2S X mr	715001720	1 140,00 zł
	G2, G2L (MAX and X mr 1000R models only)	715001668	1 093,00 zł
	G2, G2L (except MAX models)	715001597 · Mossy Oak Break-Up Country Camo	1 215,00 zł
	G2 (6x6 models only)	715005095	2 281,00 zł
	G2 MAX (6x6 models only)	715004488	1 561,00 zł
	G2L (6x6 models only)	715005261	1 390,00 zł
	G2L MAX (6x6 models only)	715006024	1 226,00 zł

Storage Cover



- Weather-resistant storage covers.
- For vehicle storage only.
- UV-resistant solution-dyed polyester construction.
- Quick and easy installation.
- Designed to perfectly fit your vehicle with or without Can-Am accessories.

Flag

715000277 · Yellow 151,00 zł



- Make sure everyone knows what you're riding.
- Perfect for the dunes and new riders.
- 8-ft. (2.4 m) length.
- Includes Flag Mount (715000127).

Flag Mount

(Not illustrated)

715000127 110,00 zł

Bolt-On[†] Retractable Ratcheting Tie-Downs

295101072 177,00 zł



- Perfect for transporting your powersport vehicle or securing loads.
- Mounts easily: Bolts on any flat surface (e.g., truck bed or frame).
- 1" x 6' (2.5 cm x 1.8 m) tie-down strap with heavy-duty stitching that delivers a 500 lb (226 kg) working load strength and 1,500 lb (680 kg) break strength.
- Convenient retractable push button automatically slackens, spools and stores away strap, while the ratchet mechanism tightens the strap snugly to secure your vehicle or load into place.
- Rubber ratcheting handle provides firm grip, and the hook is vinyl coated to protect whatever surface it hooks into.
- Sold in pairs.

Ratchet Tie-Downs

715008309 · Black/Gray 147,00 zł



- 400 lb (181 kg) safe working load.
- 1" x 10' (2.5 cm x 3 m) strap with Can-Am, Sea-Doo, and Ski-Doo logos.
- Deluxe ratchet with rubber handle.
- Coated S hooks.
- Pack of 2.

Heavy-Duty Ratchet Tie-Down

715008308 219,00 zł



- 1,000 lb (454 kg) safe working load.
- 1.5" x 6' (38 mm x 1.8 m) strap with BRP brands.
- Deluxe ratchet with rubber handle.
- Black-coated clip hooks.
- 12" (300 mm) webbing included.
- Pack of two.

Shifter Lock

G2, G2L

715007337 290,00 zł



- Secure the vehicle's shifter by locking it in position.
- Prevents the vehicle from going into neutral without the lock key.

Lockable Gas Tank Cap

G2, G2L, G2S

860200387 249,00 zł
619590085 · (Scandinavia) 215,00 zł



- Protects your fuel.
- Meets EPA requirements.

License Plate Bracket

G2L

715002498 110,00 zł

G2S

715001401 117,00 zł



- Provides specific area to install license plate.
- Mounts to rear of vehicle.

Cennik zawiera sugerowane ceny detaliczne brutto w walucie PLN. Ceny mogą ulec zmianie bez wcześniejszego uprzedzenia.
Cennik nie jest ofertą w rozumieniu prawa.

APACHE TRACK SYSTEMS

Apache Track Systems

Apache Backcountry Track System	G2 (except 6x6 models), G2L, G2S	34 145,00 zł	715005247
--	----------------------------------	--------------	------------------



- Designed to deliver the best flotation level and deep-snow performance on the market.
- Contact patch is 23% bigger than the Apache 360 LT.
- Impressive added ground clearance of 7" (18 cm), keeps the vehicle out of deep snow.
- Aggressive track design with 2" (5 cm) lug height for maximum traction on snow.
- Apache Backcountry Mounting Kit and engine and air intake pre-filters are required.
- For winter use only.

Installation of some accessories shown may impact vehicle compliance with some regulations. Consult your local dealer for information.

Apache Backcountry Mounting Kit (Not illustrated)	G2 2018 & prior, G2S 2018 & prior, G2L	2 656,00 zł	715004830
	G2 2019 & up, G2S 2019 & up	2 656,00 zł	715004796

- Required for installation of the Apache Backcountry Track System.
- DPS module and pre-filter are required and sold separately.
- *Installation of some accessories shown may impact vehicle compliance with some regulations. Consult your local dealer for information.*

Apache XC and XC LT

NEW Apache XC LT Track System	G2 2019 & up, G2S 2019 & up	34 927,00 zł	715007719
--------------------------------------	-----------------------------	--------------	------------------



- Long Track version.
- Brand-new track design to optimize driving off and in deep snow conditions.
- Reduction in steering effort thanks to the 4 wheels tandem.
- Vibrations are reduced due to the alignment of the wheels with the rolling band of the track and the shaft damper mounted tandem.
- Better steering precision because of this wheel and track alignment due to good ground contact.
- 1.25" (3.175 cm) lugs in the front and in the back for better traction and lateral stability.
- Track width: front 12.5" and rear 15".
- Adds 3" (7.62 cm) of ground clearance versus 27" tires.
- Additional shaft dampers, tandem dampers, track design and wheel layout significantly reduce NVH (noise vibration harshness).
- Central guide for optimized track alignment and reduced occurrences of detracking.
- Optimized track layout with increased angle of attack for better obstacle crossing and snow performance.
- Stamped and welded steel frame for improved strength and durability.
- Easy maintenance with replaceable hub and wheel bearings.
- Main hub is oil bath with 3 bearings inside for consistent lubrication.
- DPS module and engine and CVT pre-filter required.
- Mounting kit sold separately.

Installation of some accessories shown may impact vehicle compliance with some regulations. Consult your local dealer for information.

NEW Apache XC Track System	G2 2019 & up, G2S 2019 & up	28 929,00 zł	715008664
-----------------------------------	-----------------------------	--------------	------------------



- Brand-new track design to optimize driving off and in deep snow conditions.
- Reduction in steering effort thanks to the 4 wheels tandem.
- Vibrations are reduced due to the alignment of the wheels with the rolling band of the track and the shaft damper mounted tandem.
- Better steering precision because of this wheel and track alignment due to good ground contact.
- 1.25" (3.175 cm) lugs in the front and in the back for better traction and lateral stability.
- Track width: front 12.5" and rear 15".
- Adds 3.25" of ground clearance vs 25" tires.
- Additional shaft dampers, tandem dampers, track design and wheel layout significantly reduce NVH (noise vibration harshness).
- Central guide for optimized track alignment and reduced occurrences of detracking.
- Optimized track layout with increased angle of attack for better obstacle crossing and snow performance.
- Stamped and welded steel frame for improved strength and durability.
- Easy maintenance with replaceable hub and wheel bearings.
- Main hub is oil bath with 3 bearings inside for consistent lubrication.
- DPS module and engine and CVT pre-filter required.
- Mounting kit sold separately.

Installation of some accessories shown may impact vehicle compliance with some regulations. Consult your local dealer for information.

NEW Apache XC & XC LT Mounting Kit (Not illustrated)	G2 2019 & up, G2S 2019 & up	1 829,00 zł	715008200
--	-----------------------------	-------------	------------------

- Required for installation of the Apache XC and XC LT Track System.
- Track DPS Module and Pre-Filter not included.

Cennik zawiera sugerowane ceny detaliczne brutto, w walucie PLN. Ceny mogą ulec zmianie bez wcześniejszego uprzedzenia.

Cennik nie jest ofertą w rozumieniu prawa.

Apache 360 & 360 LT

Apache 360 Track System

G2 (except 6x6 models), G2L, G2S

27 627,00 zł

715006323



- Multifunctional tracks perfect for any Can-Am ATV.
- Average ground clearance of 16" (41 cm).
- 1" (2.5 cm) lugs in the front and 1.25" (3.2 cm) in the back.
- Apache 360 and 360 LT Mounting Kit and engine and air intake pre-filters are required.
- EC compliant.

Installation of some accessories shown may impact vehicle compliance with some regulations. Consult your local dealer for information.

Apache 360 LT Track System

G2, G2L, G2S

34 040,00 zł

715005103



- Multifunctional tracks designed to support heavy loads and to fit on most Can-Am Off-Road vehicles.
- Extra contact patch adjustment for better performance over rough terrain.
- Contact patch is 7 to 9% bigger than the Apache 360's. Average ground clearance of 16" (41 cm). 1" (2.5 cm) lugs in the front and 1.25" (3.2 cm) in the back.
- EC compliant.
- ATV: Apache 360 and 360 LT Mounting Kit, Track DPS Module and Engine and CVT air intake pre-filters are required and sold separately.

Installation of some accessories shown may impact vehicle compliance with some regulations. Consult your local dealer for information.

Apache 360 LT 6x6

Apache 360 LT (6x6) Track System

G2, G2L (6x6 only)

37 898,00 zł

715005104



- Multifunctional tracks designed to support heavy loads and to fit on most Can-Am Off-Road vehicles.
- Front wheel height adjustment provides enhanced attack angle and better performance over rough terrain when raised or increased contact patch for improved flotation when lowered.
- Average ground clearance increase of 4.5" (11.4 cm).
- 1" (2.5 cm) lugs in the front and 1.25" (3.2 cm) in the back.
- Apache 360 LT Mounting Kit, Track DPS Module and Engine and Pre-Filter Kit are required.
- Reliable heavy-duty build.
- EC compliant.
- Exclusively for the Outlander 6x6.
- Recommended for use on snow only.

Installation of some accessories shown may impact vehicle compliance with some regulations. Consult your local dealer for information.

Apache 360 & 360 LT Mounting Kit

(Not illustrated)

G2 2018 & prior (except 6x6 models) G2S 2018 & prior, G2L

1 549,00 zł

715007207

G2 2019 & up (except 6x6 models), G2S 2019 & up

1 549,00 zł

715007206

G2 2018 & prior, G2L (6x6 models)

913,00 zł

715004991

G2 2019 & up (6x6 models)

913,00 zł

715005105

- Required to install Apache 360 and 360 LT Track Systems.
- DPS module and pre-filter not included.

Installation of some accessories shown may impact vehicle compliance with some regulations. Consult your local dealer for information.

Apache Track System Accessories

Track DPS Module

(Not illustrated)

G2, G2L, G2S

442,00 zł

715007338

- An innovative DPS module that ensures speedometer accuracy and optimized steering assist, which make for perfect track control and riding ease.
- Required to install the Apache and Backcountry Track Systems.

Installation of some accessories shown may impact vehicle compliance with some regulations. Consult your local dealer for information.

Air Intake Pre-Filter

234,00 zł

715003483



- Adds extra protection to your engine in harsh riding conditions.
- Filter blocks particles larger than 0.007" (0.19 mm).
- Easy, tool-less installation.
- Necessary to maintain vehicle warranty when tracks are installed.
- Required to install the Apache and Backcountry Track Systems.
- Standard on Outlander 650, 650 X mr, 850, 1000, 1000R engines and G2L PRO.

Cennik zawiera sugerowane ceny detaliczne w walucie PLN. Ceny mogą ulec zmianie bez wcześniejszego uprzedzenia.

Cennik nie jest ofertą w rozumieniu prawa.

Engine Air Intake Pre-Filter	G2, G2L, G2S	188,00 zł	715004729
-------------------------------------	--------------	-----------	------------------



- Adds extra protection to your engine in harsh riding conditions.
- Filter blocks particles larger than 0.005" (0.13 mm).
- Necessary to maintain vehicle warranty when tracks are installed.

Idler Wheel Kit	Apache Backcountry Track System (rear tracks only)	267,00 zł	860201230 · 141 mm
------------------------	---	-----------	------------------------------



- Reduces drag and rolling resistance.
- Includes 2 wheels, brackets and hardware.
- Add up to 2 kits per rear track.
- Can extend slider life in hardened snow conditions.

Sliders with Vespel[®] Inserts	Apache Backcountry Track System	636,00 zł	503194815
--	---------------------------------	-----------	------------------



- Use DuPont Vespel inserts for less friction.
- Longer life.
- Can be cut to desired length.
- 8 needed per vehicle.
- Sold individually.

Rail Ice Scratchers	Apache Backcountry Track System	590,00 zł	860201728
----------------------------	---------------------------------	-----------	------------------



- Provide additional lubrication in hard and icy conditions.
- Rail mounted, small, light.
- Design expands on coil concept to allow reversing without damage.
- Easily stored when not in use.

Cennik zawiera sugerowane ceny detaliczne brutto w walucie PLN. Ceny mogą ulec zmianie bez wcześniejszego uprzedzenia.
Cennik nie jest ofertą w rozumieniu prawa.

APACHE TRACK SYSTEMS FITTING GUIDE

Apache Backcountry

Model Year / Model	Track	Track Mount	Track DPS Module	Prefilter without Snorkel	Prefilter with Snorkel
2015 & Up G2L	715005247	715004830	715007338	715004729	715003483 (standard on G2 models and G2L PRO model)
2018 & Prior G2, G2S					
2019 & Up G2, G2S					
2019 & Up G2 1000R	715005247 & 715005891	715004796			

Apache XC and XC LT

Model Year / Model	Track	Track Mount	Track DPS Module	Prefilter without Snorkel	Prefilter with Snorkel
2019 & Up G2, G2S	715007719 and 715008664	715008200	715007338	715004729	715003483 (standard on G2 models and G2L PRO model)

Apache 360 and Apache 360 LT

Model Year / Model	Track	Track Mount	Track DPS Module	Prefilter without Snorkel	Prefilter with Snorkel
2015 & Up G2L	715006323 (Apache 360) OR 715005103 (Apache 360 LT)	715007207	715007338	715004729 & 715003483 (standard on G2 models and G2L PRO model)	715004729
2018 & Prior G2, G2S					
2019 & Up G2, G2S		715007206			

Apache 360 LT 6x6

Model Year / Model	Track	Track Mount	Track DPS Module	Prefilter without Snorkel	Prefilter with Snorkel
2018 & Prior G2 6x6	715005104	715004991	715007338	715004729 & 715003483 (standard on G2 models and G2L PRO model)	715004729
2019 & Up G2L 6x6					
2019 & Up G2 6x6		715005105			

Cennik zawiera sugerowane ceny detaliczne brutto w walucie PLN. Ceny mogą ulec zmianie bez wcześniejszego uprzedzenia.
Cennik nie jest ofertą w rozumieniu prawa.

PROMOUNT PLOWS

PROMOUNT PLOW KITS

Reference Chart

	54" Black Steel	54" Yellow Steel	60" Black Steel	60" Yellow Steel	66" Black Steel	66" Yellow Steel	60" Flex2	66" Flex 2
Plow Kit	715007753	715008178	715007754	715008179	715007755	715008180	715008181	715008182
Blade	715004472	715005316	715004202	715005317	715006337	-	715004203	715006265
Push Frame	715007752	715007752	715007752	715007752	715007752	715007752	715007752	715007752
Mounting Plate	715007751	715007751	715007751	715007751	715007751	715007751	715007751	715007751

Steel Plows

Can-Am ProMount Steel Plow Kits 54" (137 cm) Blade

G2, G2L, G2S

■ 715007753 · Black

■ 715008178 · Yellow



- These kits include:
 - Can-Am ProMount Steel Blade
 - Push Frame with Quick-Attach System
 - Mounting Plate

Can-Am ProMount Steel Plow Kits 60" (152 cm) Blade

G2, G2L, G2S

■ 715007754 · Black

■ 715008179 · Yellow



- These kits include:
 - Can-Am ProMount Steel Blade
 - Push Frame with Quick-Attach System
 - Mounting Plate

Can-Am ProMount Steel Plow Kits 66" (168 cm) Blade

G2, G2L, G2S

■ 715007755 · Black

■ 715008180 · Yellow



- These kits include:
 - Can-Am ProMount Steel Blade
 - Push Frame with Quick-Attach System
 - Mounting Plate

Can-Am ProMount Steel Blades 54" (137 cm) Blade

Fits ProMount Push Frame

■ 715004472 · Black 1 644,00 zł

■ 715005316 · Yellow 1 509,00 zł



- Blades available individually to create your own kit.
- Compatible with Can-Am ProMount Blade accessories to further enhance plow versatility (some plow accessories are not compatible with 54" (137 cm) plows).
- Not compatible with ProMount Drift Cutters, Blade Extensions and Edge Markers.
- Clears 50" (127 cm) when plow is fully angled.
- Blade height of 14.75" (37 cm).

Can-Am ProMount Steel Blades 60" (152 cm) Blade

Fits ProMount Push Frame

■ 715004202 · Black 1 779,00 zł

■ 715005317 · Yellow 1 644,00 zł



- Blades available individually to create your own kit.
- Compatible with Can-Am ProMount Blade accessories to further enhance plow versatility.
- Clears 54" (137 cm) when plow is fully angled.
- Blade height of 17" (43 cm).

Cennik zawiera sugerowane ceny detaliczne brutto w walucie PLN. Ceny mogą ulec zmianie bez wcześniejszego uprzedzenia.
Cennik nie jest ofertą w rozumieniu prawa.

**Can-Am ProMount Steel Blades
66" (168 cm) Blade**

Fits ProMount Push Frame

■ **715006337** · Black

2 285,00 zł



- Blades available individually to create your own kit.
- Compatible with Can-Am ProMount Blade accessories to further enhance plow versatility.
- Clears 60" (152 cm) when plow is fully angled.
- Blade height of 17" (43 cm).

**Can-Am ProMount Steel Blades
72" (183 cm) Blade**

Fits ProMount Push Frame

■ **715004474** · Black

2 601,00 zł

■ **715006021** · Yellow

2 190,00 zł



- Blades available individually to create your own kit.
- Compatible with Can-Am ProMount Blade accessories to further enhance plow versatility.
- Clears 66" (168 cm) when plow is fully angled.
- Blade height of 17" (43 cm).

Can-Am ProMount Flex2 Plow Kit

Can-Am ProMount Flex2 – 60" (152 cm) Plow Kit

G2, G2L, G2S

715008181



- These kits include:
 - Can-Am ProMount Flex2 Blade
 - Push Frame with Quick-Attach System
 - Mounting Plate

**NEW Can-Am ProMount Flex2 – 66" (168 cm)
Plow Kit**

G2, G2L, G2S

■ **715008182** · Black



- This kit includes:
 - Can-Am ProMount Flex2 Blade
 - Push Frame with Quick-Attach System
 - Mounting Plate

Angle Plows

**Can-Am ProMount Angle Blades
60" (152 cm) Steel Oneway State Blade**

G2, G2L, G2S

715007261

2 375,00 zł



- Make the job easier with the right tools, clear long alleys and make the task easier by sending the snow further out of the way.
- Wing end of plow measures 25" (63 cm) high and tapers down to 17" (43 cm).
- One-way "winged" state plow designed to throw snow higher.
- Rubber Flap (715007299) designed to keep snow away from the driver is offered as accessory (sold separately).
- Can-Am branded.

**Can-Am ProMount Angle Blades
66" (168 cm) Steel Oneway State Blade**

G2, G2L, G2S

715007263

2 831,00 zł



- Make the job easier with the right tools, clear long alleys and make the task easier by sending the snow further out of the way.
- Wing end of plow measures 25" (63 cm) high and tapers down to 17" (43 cm).
- One-way "winged" state plow designed to throw snow higher.
- Rubber Flap (715007299) designed to keep snow away from the driver is offered as accessory (sold separately).
- Can-Am branded.

Can-Am ProMount Angle Blades 72" (183 cm) Steel Oneway State Blade	G2, G2L, G2S	715007264	3 012,00 zł
---	--------------	------------------	-------------



- Make the job easier with the right tools, clear long alleys and make the task easier by sending the snow further out of the way.
- Wing end of plow measures 26" (67 cm) high and tapers down to 17" (43 cm).
- One-way "winged" state plow designed to throw snow higher.
- Rubber Flap (715007299) designed to keep snow away from the driver is offered as accessory (sold separately).
- Can-Am branded.

ProMount One-Way State Blade Rubber Flap <i>(Not illustrated)</i>		715007299	552,00 zł
---	--	------------------	-----------

- Allows for more efficient snow projections in various snow conditions.

Can-Am ProMount Flex2 Plows

Can-Am ProMount Flex2 60" (152 cm) Blade	Fits ProMount Push Frame	715004203	2 235,00 zł
---	--------------------------	------------------	-------------



- Plow blade made of UHMWPE, flexible and impact absorbing material prevents damaging your plow when accidental impacts occur.
- Replaceable wear blade.
- Large pin designed for easy blade rotation to eliminate snow buildup at pivot point.
- Blade design provides best snow roll-off at any angle.
- Compatible with Can-Am ProMount Blade accessories to further enhance plow versatility.
- Clears 54" (137 cm) when plow is fully angled.
- Blade height of 17" (43 cm).

Can-Am ProMount Flex2 66" (168 cm) Blade	Fits ProMount Push Frame	715006265	2 556,00 zł
---	--------------------------	------------------	-------------



- Plow blade made of UHMWPE, flexible and impact absorbing material prevents damaging your plow when accidental impacts occur.
- Replaceable wear blade.
- Large pin designed for easy blade rotation to eliminate snow buildup at pivot point.
- Blade design provides best snow roll-off at any angle.
- Clears 60" (152 cm) when plow is fully angled.
- Blade height of 17" (43 cm).
- Compatible with Can-Am ProMount Blade accessories to further enhance plow versatility.

Can-Am ProMount Flex2 72" (183 cm) Blade	Fits ProMount Push Frame	715004485	2 922,00 zł
---	--------------------------	------------------	-------------



- Plow blade made of UHMWPE, flexible and impact absorbing material prevents damaging your plow when accidental impacts occur.
- Replaceable wear blade.
- Large pin designed for easy blade rotation to eliminate snow buildup at pivot point.
- Blade design provides best snow roll-off at any angle.
- Compatible with Can-Am ProMount Blade accessories to further enhance plow versatility.
- Clears 66" (168 cm) when plow is fully angled.

Can-Am ProMount Plow Accessories

Can-Am ProMount Push Frame with Quick-Attach System	G2, G2L, G2S	715007752	2 285,00 zł
--	--------------	------------------	-------------









- Heavy-duty steel tubes designed to withstand the roughest use.
- Mid-mount carriage provides ultimate push strength and traction.
- Designed for maximum plow lift height.
- Features a self aligning quick-attach system, an easy foot release pedal and an ergonomic handle for plow angle adjustment.
- Plow Roller Fairlead and Plow Limit Switch recommended to extend winch cable lifespan.
- Can-Am ProMount Mounting Plate required for installation.
- Blade swivels left or right, 5 positions.
- Large pin designed for easy blade rotation to eliminate dirt and snow buildup at pivot point.

Can-Am ProMount Mounting Plate	G2, G2L, G2S	715007751	732,00 zł
---------------------------------------	--------------	------------------	-----------

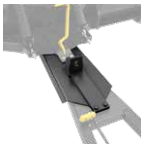

- Required to install the Can-Am ProMount Push Frame with Quick-Attach System.
- Mounting plate precision-designed to stay on year round without compromising ground clearance.
- Fits on ATVs with or without Can-Am Skid Plates.
- Plow Roller Fairlead included.

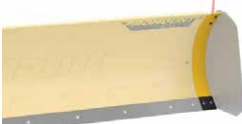
Cennik zawiera sugerowane ceny detaliczne brutto w walucie PLN. Ceny mogą ulec zmianie bez wcześniejszego uprzedzenia.
Cennik nie jest ofertą w rozumieniu prawa.

Can-Am ProMount Push Frame Extension	G2, G2L, G2S	715006257	802,00 zł
	<ul style="list-style-type: none"> • 12" (30 cm) push frame extension. • Required when plow is installed with Apache Track System. 		
Can-Am ProMount Edge Markers	G2, G2L, G2S	715004206	209,00 zł
	<ul style="list-style-type: none"> • Help locate the edges of your plow. • Height: 24" (60 cm). • Sold in pairs. • Compatible with Can-Am ProMount Steel and Flex2 Blades with or without Blade Extensions (except for the Can-Am ProMount Steel 54" (137 cm) Blades). 		
Can-Am ProMount Drift Cutters	G2, G2L, G2S	715006258	732,00 zł
	<ul style="list-style-type: none"> • Help keep snow in the plow. • Dimensions: 17" x 13" (43.2 cm x 33 cm). • Sold in pairs. • Compatible with Can-Am ProMount Steel and Flex2 Blades with or without Blade Extensions (except for the Can-Am ProMount Steel 54" (137 cm) Blades). 		
Can-Am ProMount Curved Wear Blade	G2, G2L, G2S	715007791 · 60" (152 cm) 715007792 · 66" (168 cm)	608,00 zł 608,00 zł
	<ul style="list-style-type: none"> • Wear blade designed with a folded back bottom lip. • The increased surface allows for less digging while plowing uneven surfaces. • Ideal for snow covered gravel, grass, paver stone and other soft surfaces. 		
Can-Am ProMount Plastic Wear Blade	G2, G2L, G2S	715004480 · 54" (137 cm) 715004481 · 60" (152 cm) 715004482 · 66" (168 cm) 715004483 · 72" (183 cm)	741,00 zł 845,00 zł 949,00 zł 1 058,00 zł
	<ul style="list-style-type: none"> • To help prevent scratches on smooth driveways and markable surfaces. 		
Can-Am ProMount Blade Extensions	G2, G2L, G2S	■ 715004205 · Black ■ 715005319 · Yellow	636,00 zł 636,00 zł
	<ul style="list-style-type: none"> • Add 3" (8 cm) each side. • Compatible with Can-Am ProMount Blades (except for Can-Am ProMount Steel 54" (137 cm) Blade). • Longer Wear Blade can be installed to further extend the extra length already provided by the extensions. • Compatible with Can-Am ProMount Steel and Flex2 Blades (except for the Can-Am ProMount Steel 54" (137 cm) Blades). 		
Back Drag Blade	ProMount Plows (60" and more)	715007794	1 475,00 zł
	<ul style="list-style-type: none"> • ¼ thick steel swivel scraper. • Lifts up when the vehicle is moving forward so as to not affect the scraping. • Increased capacity to pull snow. • More aggressive scraping in reverse mode. • Lifts the blade off the ground so that it scrapes evenly. • Adjustable in length for compatibility with 60", 66" and 72" blades. • Compatible with ProMount blades (Flex and Steel). 		

Cennik zawiera sugerowane ceny detaliczne brutto w walucie PLN. Ceny mogą ulec zmianie bez wcześniejszego uprzedzenia.
Cennik nie jest ofertą w rozumieniu prawa.

Plow Roller Fairlead	G2, G2L, G2S	705009222	339,00 zł
-----------------------------	--------------	------------------	-----------



- Larger diameter lower roller reduces wear on wire rope for plow application.
- Can be used with all ProMount plows.
- Included in Plow Mounting Plate Kit (715007751).

Pulley Kit for Alpine Super-Duty Plow	G2, G2L	715000279	305,00 zł
--	---------	------------------	-----------



- Pulley kit to be used in conjunction with the winch when using a snow plow.
- Recommended to increase winch efficiency.
- To be used with the XT Front Bumper.

Synthetic Winch Cable for Plowing		715000540	245,00 zł
--	--	------------------	-----------



- Specially designed for plowing applications.
- 8' (2.4 m) section of durable, extra-strong synthetic rope.
- Stands up to repeated, sharp angle pulls used to lift heavy plow blades.
- Temporarily replace your winch rope for plow season to save wear and tear on wire rope.

Plow Limit Switch (Not illustrated)	G2, G2L, G2S	715006259	712,00 zł
---	--------------	------------------	-----------

- For controlling the cable tension when over-raising your plow system.
- Prevents winch, plow push frame and vehicle damage.

Can-Am ProMount Plow Angling System	G2, G2L, G2S	715009657	2 742,00 zł
--	--------------	------------------	-------------



- Converts your plow system into an easy-to-control unit from the driver's seat.
- Using one hand to control all plow motions will allow you to easily concentrate and manage your plowing tasks.
- Compatible with ProMount Blade.
- Push Frame (715007752) is required.
- Push Frame Extension (715006257) is required for installation with the Front Rancher Bumper.
- Winch and plow sold separately.

Cennik zawiera sugerowane ceny detaliczne brutto w walucie PLN. Ceny mogą ulec zmianie bez wcześniejszego uprzedzenia.
Cennik nie jest ofertą w rozumieniu prawa.



G3, G3L ACCESSORIES

LinQ Accessories: Easy On, Easy Off Cargo	56
Cargo & Storage	64
Can-Am Windshields	64
Handlebars & Mirrors	66
Skid Plates	67
Bumpers & Guards	68
Lights & Electrical	69
Winches	71
Hitches	73
Performance	73
Covers & Add-Ons	74
Apache Track Systems	75
ProMount Plows	78



BUNDLE UP TO NEVER COMPROMISE. YOUR ATV BUNDLES.

STEP 1: CHOOSE YOUR ESSENTIAL BUNDLE

		G3 G3 MAX	G3L G3L MAX
STARTER	Console Extension	715009218	715005368
	Console Extension USB Power Outlet	715008750	715008750
	LinQ Cargo Box (53 L)	715006997	715006997
	LinQ Tool Kit	715006829	715006829
ADVANCED	Fender Flares	N/A	715006336
	Driver Full Wrap Handguards	715005361	715005361
	LinQ Modular Box (10 L)	715005494	715005494
	Adventure High Windshield	715009453	715005377
PEAK	Bluetooth Handlebar Soundbar by MTX	219400840	219400840
	Adventure High Windshield	715009453	715005377
	Trailer cover	715005074 715005075	715005074 715005075
	3.5" LED Driving Lights	715009775	715009775

STEP 2: PICK YOUR ADD-ON BUNDLE

		G3 G3 MAX	G3L G3L MAX
ADVENTURE	LinQ Stackable Fuel Caddy – 4 Gallons	860202246	860202246
	Skid plate kit	715009216 715009217	715005309 715005310
	LinQ Trunk Box	715009471 715009472	715009471 715009472
HUNT	LinQ Gun Case	715009240	715009240
	LinQ Rack Extension	715009475	715004954
	LinQ Gear Grips	715005340	715005340
	LinQ Fuel caddy	860202246	860202246
FORESTRY	LinQ Chainsaw Holder	715004975	715004975
	Large Cargo Box	N/A	715007001
	LinQ Tool Holder	715007358	715007358
WINTER	Integrated Heated Grips & Thumb Throttle Combo	715005072	715005072
	Adventure Side Wind Deflectors	715009462	715005862
	Passenger Wind Deflectors	715001669 (MAX only)	715001669 (MAX only)
	Heated Passenger Grips & Visor Outlet	715005358 (MAX only)	715005358 (MAX only)
FARMING	Utility Basket	715005274	715005274
	Large cargo box	N/A	715007001
	Tool Holder Bolt-On	715008896	715008896
SNOW	Apache XC Track Kit	715008664	715008664
	Apache XC Track mounting kit	715008264	715008264
	ProMount Steel Plow kit 60" Black	715006203	715006203

Cennik zawiera sugerowane ceny detaliczne brutto w walucie PLN. Ceny mogą ulec zmianie bez wcześniejszego uprzedzenia.
Cennik nie jest ofertą w rozumieniu prawa.

LINQ ACCESSORIES: EASY ON, EASY OFF CARGO



- No tools needed: Quickly install and remove accessories by hand.
- Equip your Can-Am vehicle for specialized tasks in no time.
- Sturdy mounting system that holds up to the roughest terrain.

G3

	① Front Cargo Compartment	② Front Rack	③ Rear Cargo Compartment	④ Rear Rack	LinQ Can Stack on Top
LinQ Accessories with 16" Base					
LinQ 4.2 Gal (16 L) Cooler 219400964 • Black / 295100698 • White	YES, with LinQ Base Installation Kit 860201806 Can be installed inside* or on the front cargo compartment.	NO	YES, with LinQ Base Installation Kit 860201806	NO	NO
LinQ Tool Box 715008111					
LinQ SR 5.5 Gal (21 L) Bag 860202449	YES, with LinQ Base Installation Kit 860201806 Must be installed on the front cargo compartment lid only.				
LinQ 4.5 Gal (17 L) Sport Bag 860202447					
LinQ Modular Box (10 L) 715005494					
LinQ Modular Box (20 L) 715007112	YES, with LinQ Base Installation Kit 860201806 Can be installed inside* or on the front cargo compartment.				
LinQ Modular Box (30 L) 715006830					
LinQ Tool Kit 715006829					
LinQ Roll-Top Bag 715008110	YES, with LinQ Base Installation Kit 860201806 Must be installed on the front cargo compartment lid only.				
LinQ Fuel Caddy – 4 Gallons 860202246	YES, with LinQ Base Installation Kit 860201806 Must be installed inside* the front cargo compartment only.				
LinQ Oil Caddy – 1 Gallon 860202445					
LinQ Gun Case 715009240	YES, with LinQ Base Installation Kit 860201806 Must be installed on the front cargo compartment lid.				
LinQ Accessories with 36" Base					
LinQ Cargo Basket (90 L) 715010173	NO	YES	NO	YES	NO
Front LinQ Cargo Box (90 L) 715005272	YES			NO	
LinQ Cargo Box (53 L) 715010172				YES	YES
LinQ Low Profile Box (63 L) 715007827					
LinQ Trunk Box (145 L) 715009471	NO	NO	YES, remove the rear rack for installation.	NO	NO
LinQ Trunk Box (87 L) – G3 715009499				YES	
LinQ 9.2 Gal (35 L) Cooler 715006998				NO	
LinQ Gun Case 715009240			YES	NO	
LinQ Holders and Racks					
LinQ Gear Grips 715005340	YES, with LinQ Base Installation Kit 860201806	YES	YES, with LinQ Base Installation Kit 860201806	YES	NO
LinQ Tool Holder 715007358					
LinQ Chainsaw Holder 715004975	YES	NO	NO	NO	
LinQ Front Rack Extension 715009281	NO	YES			
LinQ Rear Rack Extension 715009475		NO			YES

*Removal of front cargo compartment lid is required.

Cennik zawiera sugerowane ceny detaliczne brutto w walucie PLN. Ceny mogą ulec zmianie bez wcześniejszego uprzedzenia.
Cennik nie jest ofertą w rozumieniu prawa.

LINQ ACCESSORIES: EASY ON, EASY OFF CARGO



- No tools needed: Quickly install and remove accessories by hand.
- Equip your Can-Am vehicle for specialized tasks in no time.
- Sturdy mounting system that holds up to the roughest terrain.

G3L

	① Front Cargo Compartment	② Front Rack	③ Rear Cargo Compartment	④ Rear Rack	LinQ Can Stack on Top				
LinQ Accessories with 16" Base									
LinQ 4.2 Gal (16 L) Cooler 219400964 • Black / 295100698 • White	YES, with LinQ Base Installation Kit 860201806 Can be installed inside* or on the front cargo compartment.	NO	YES, with LinQ Base Installation Kit 860201806	NO	NO				
LinQ Tool Box 715008111									
LinQ SR 5.5 Gal (21 L) Bag 860202449	YES, with LinQ Base Installation Kit 860201806 Must be installed on the front cargo compartment lid only.								
LinQ 4.5 Gal (17 L) Sport Bag 860202447	YES, with LinQ Base Installation Kit 860201806 Can be installed inside* or on the front cargo compartment.								
LinQ Modular Box (10 L) 715005494									
LinQ Modular Box (20 L) 715007112									
LinQ Modular Box (30 L) 715006830									
LinQ Tool Kit 715006829								YES	
LinQ Roll-Top Bag 715008110	YES, with LinQ Base Installation Kit 860201806 Must be installed on the front cargo compartment lid only.					NO	NO	NO	
LinQ Fuel Caddy - 4 Gallons 860202246	YES, with LinQ Base Installation Kit 860201806 Must be installed inside* the front cargo compartment only.								
LinQ Oil Caddy - 1 Gallon 860202445									
LinQ Gun Case 715009240	YES, with LinQ Base Installation Kit 860201806 Must be installed on the front cargo compartment lid.				NO				
LinQ Accessories with 36" Base									
LinQ Large Cargo Box 715007001	NO	NO	YES, remove the rear rack for installation.	NO	NO				
LinQ Cargo Basket (90 L) 715005274									
LinQ Cargo Box (53 L) 715006997		NO					YES		
LinQ Low Profile Box (63 L) 715007827						YES	NO	YES	
LinQ Cargo Box (90L) 715005272		YES					NO	NO	
LinQ Trunk Box (87 L) - G3L 715009312							YES	NO	
LinQ Trunk Box (145 L) 715009471		NO				NO	NO	NO	YES
LinQ 9.2 Gal (35 L) Cooler 715006998							NO	YES	NO
LinQ Gun Case 715009240						YES	NO	NO	NO
LinQ Holders and Racks									
LinQ Gear Grips 715005340	YES, with LinQ Base Installation Kit 860201806	YES	YES, with LinQ Base Installation Kit 860201806	YES	NO				
LinQ Tool Holder 715007358									
LinQ Rack Extension 715004954	NO		NO	NO	NO				
LinQ Chainsaw Holder 715004975	YES	NO				NO			

*Removal of front cargo compartment lid is required.

Cennik zawiera sugerowane ceny detaliczne brutto w walucie PLN. Ceny mogą ulec zmianie bez wcześniejszego uprzedzenia.
Cennik nie jest ofertą w rozumieniu prawa.

LINQ ACCESSORIES: EASY ON, EASY OFF CARGO



- No tools needed: Quickly install and remove accessories by hand.
- Equip your Can-Am vehicle for specialized tasks in no time.
- Sturdy mounting system that holds up to the roughest terrain.

G3 MAX

LinQ Accessories with 16" Base		① Front Cargo Compartment	② Front Rack	③ Rear Cargo Compartment	④ Rear Rack	LinQ Can Stack on Top		
	LinQ 4.2 Gal (16 L) Cooler 219400964 • Black / 295100698 • White	YES, with LinQ Base Installation Kit 860201806 Can be installed inside* or on the front cargo compartment.	NO	NO	NO	NO		
	LinQ Tool Box 715008111							
	LinQ SR 5.5 Gal (21 L) Bag 860202449	YES, with LinQ Base Installation Kit 860201806 Must be installed on the front cargo compartment lid only.						
	LinQ 4.5 Gal (17 L) Sport Bag 860202447	YES, with LinQ Base Installation Kit 860201806 Can be installed inside* or on the front cargo compartment.					YES, with LinQ Base Installation Kit 860201806	
	LinQ Modular Box (10 L) 715005494						YES	
	LinQ Modular Box (20 L) 715007112						NO	
	LinQ Modular Box (30 L) 715006830						NO	
	LinQ Tool Kit 715006829						YES	
	LinQ Roll-Top Bag 715008110	YES, with LinQ Base Installation Kit 860201806 Must be installed on the front cargo compartment lid only.					NO	
	LinQ Fuel Caddy - 4 Gallons 860202246	YES, with LinQ Base Installation Kit 860201806 Must be installed inside* the front cargo compartment only.						
	LinQ Oil Caddy - 1 Gallon 860202445							
	LinQ Gun Case 715009240	YES, with LinQ Base Installation Kit 860201806 Must be installed on the front cargo compartment lid.	NO					
LinQ Accessories with 36" Base		Front Cargo Compartment		Front Rack	Rear Cargo Compartment	Rear Rack	LinQ Can Stack on Top	
	LinQ Cargo Basket (90 L) 715010173	NO		YES	NO	YES	NO	
	Front LinQ Cargo Box (90 L) 715005272	YES				NO		NO
	LinQ Cargo Box (53 L) 715010172	NO		NO	NO	YES	YES	
	LinQ Low Profile Box (63 L) 715007827							
	LinQ Trunk Box (139 L) 715009472					YES, remove the rear rack for installation.	NO	NO
	LinQ Trunk Box (87 L) - G3 715009499					NO	YES	
	LinQ 9.2 Gal (35 L) Cooler 715006998					NO	NO	
	LinQ Gun Case 715009240					YES	NO	NO
LinQ Holders and Racks						Front Cargo Compartment	Front Rack	Rear Cargo Compartment
	LinQ Gear Grips 715005340	YES, with LinQ Base Installation Kit 860201806	YES	YES, with LinQ Base Installation Kit 860201806	YES	NO		
	LinQ Tool Holder 715007358							
	LinQ Chainsaw Holder 715004975	YES	NO	NO	NO			
	LinQ Front Rack Extension 715009281	NO	YES	NO	NO			
	LinQ Rear Rack Extension 715009475		NO		YES			

*Removal of front cargo compartment lid is required.

Cennik zawiera sugerowane ceny detaliczne brutto w walucie PLN. Ceny mogą ulec zmianie bez wcześniejszego uprzedzenia.
Cennik nie jest ofertą w rozumieniu prawa.

LINQ ACCESSORIES: EASY ON, EASY OFF CARGO



- No tools needed: Quickly install and remove accessories by hand.
- Equip your Can-Am vehicle for specialized tasks in no time.
- Sturdy mounting system that holds up to the roughest terrain.

G3L MAX

	① Front Cargo Compartment	② Front Rack	③ Rear Cargo Compartment	④ Rear Rack	LinQ Can Stack on Top			
LinQ Accessories with 16" Base								
LinQ 4.2 Gal (16 L) Cooler 219400964 • Black / 295100698 • White	YES, with LinQ Base Installation Kit 860201806 Can be installed inside* or on the front cargo compartment.	NO	NO	NO	NO			
LinQ Tool Box 715008111								
LinQ SR 5.5 Gal (21 L) Bag 860202449	YES, with LinQ Base Installation Kit 860201806 Must be installed on the front cargo compartment lid only.							
LinQ 4.5 Gal (17 L) Sport Bag 860202447	YES, with LinQ Base Installation Kit 860201806 Can be installed inside* or on the front cargo compartment.		YES, with LinQ Base Installation Kit 860201806					
LinQ Modular Box (10 L) 715005494								
LinQ Modular Box (20 L) 715007112								
LinQ Modular Box (30 L) 715006830								
LinQ Tool Kit 715006829							YES	
LinQ Roll-Top Bag 715008110	YES, with LinQ Base Installation Kit 860201806 Must be installed on the front cargo compartment lid only.					NO		
LinQ Fuel Caddy - 4 Gallons 860202246	YES, with LinQ Base Installation Kit 860201806 Must be installed inside* the front cargo compartment only.							NO
LinQ Oil Caddy - 1 Gallon 860202445								
LinQ Gun Case 715009240	YES, with LinQ Base Installation Kit 860201806 Must be installed on the front cargo compartment lid.							
LinQ Accessories with 36" Base								
LinQ Large Cargo Box 715007001	NO	NO	NO	YES	NO			
LinQ Cargo Basket (90 L) 715005274		YES		NO				
LinQ Cargo Basket (90 L) 715005272	YES			NO				
LinQ Trunk Box (87L) - G3L 715009312	NO	NO	NO		YES			
LinQ Cargo Box (53 L) 715006997		YES						
LinQ Low Profile Box (63 L) 715007827								
LinQ Trunk Box (139 L) 715009472								
LinQ 9.2 Gal (35 L) Cooler 715006998		NO	YES, remove the rear rack for installation.	NO	NO			
LinQ Gun Case 715009240		NO	NO	YES				
LinQ Gun Case 715009240		YES	NO	NO				
LinQ Holders and Racks								
LinQ Gear Grips 715005340	YES, with LinQ Base Installation Kit 860201806	YES	YES, with LinQ Base Installation Kit 860201806	YES	NO			
LinQ Tool Holder 715007358								
LinQ Rack Extension 715004954	NO		NO					
LinQ Chainsaw Holder 715004975	YES	NO		NO				

*Removal of front cargo compartment lid is required.

Cennik zawiera sugerowane ceny detaliczne brutto w walucie PLN. Ceny mogą ulec zmianie bez wcześniejszego uprzedzenia.
Cennik nie jest ofertą w rozumieniu prawa.

LinQ Accessories with 16" Base

LinQ Fuel Caddy – 4 Gallons | G3, G3L | **860202246** | 1 174,00 zł



- Quick, easy and secure installation with LinQ system.
- No-spill spout for easy use.
- 3.7 US gallon (14 L) capacity.
- Meet the new latest Flame Mitigation Device (FMD) standard.
- Must be installed in the Front Cargo Compartment.
- LinQ Base Installation Kit (860201806) required.
- No LinQ 16" accessories can be stacked on the LinQ 4-Gallon Fuel Caddy.
- Can't be installed on the rear lid due to weight limitation.
- Check local regulations regarding fuel transportation

LinQ Oil Caddy – 1 Gallon | G3, G3L | **860202445** | 689,00 zł



- 1 US gallon (3.78 L) capacity.
- Must be installed in the Front Cargo Compartment.
- LinQ Base Installation Kit (860201806) required.
- No LinQ 16" accessories can be stacked on the LinQ 1-Gallon Oil Caddy.
- Can't be installed on the rear lid due to weight limitation.

LinQ Chainsaw Holder | G3, G3L (except X mr models) | **715004975** | 885,00 zł



- This system installs a chainsaw vertically to save space on the rack and serves as a scabbard for storage.
- Pinch the blade for a solid and quick fix.
- Compatible with the majority of chainsaws available on the market as most blades go up to 18".
- Compatible with all 16" LinQ accessories that fit in the front cargo compartment.
- Allows installation of the LinQ Tool Holder.
- Not compatible with the LinQ Rack Extension when installed on the front rack of the vehicle.

LinQ Modular Box | G3, G3L | **715005494** · (10 L) | 643,00 zł
715007112 · (20 L) | 843,00 zł
715006830 · (30 L) | *843,00 zł



- Allows stacking of other modular boxes to always have the right gear accessible.
- Always have the right box size to fit everything.
- Can be installed on any LinQ Base with a 16" width.
- See table for installation location and requirements.
- Can't be installed on the rear lid due to weight limitation.

Thermal Insert for LinQ Modular Box (10 L) | G3, G3L | **219401110** | 294,00 zł



- Insulated liner.
- Fits very well in the LinQ Modular Box (10 L).
- Can contain seven 355 ml cans.
- Keeps ice cold for one day.
- Interior dimensions: 9" L x 17" W x 2½" H.

LinQ Tool Kit | G3, G3L | **715006829** | 1 619,00 zł



- Includes:
 - Cutter pliers
 - Long-nose pliers
 - Locking pliers
 - Ratchet wrench ¾" drive
 - 6" ratchet extension
 - Integrated CVT belt storage location (belt not included)
 - Long-socket 19 mm ¾" drive - 6 pts
 - Socket 18 mm ¾" drive
 - Long-socket 17 mm ¾" drive - 6 pts
 - Socket 15 mm ¾" drive
 - Socket 13 mm ¾" drive
 - Socket 10 mm ¾" drive
 - Socket 8 mm ¾" drive
 - Socket Torx T40 ¾" drive
 - Socket Torx T30 ¾" drive
 - Socket Torx T20 ¾" drive
 - Breaker bar ¾" drive
 - Combination Wrench set:
 - Wrench 13 mm
 - Wrench 10 mm
 - Wrench 8 mm
 - Wrench 19 mm
 - Wrench 18 mm
 - Wrench 15 mm
- See table for installation location and requirements.

LinQ 4.2 Gal (16 L) Cooler | G3, G3L | **219400964** · Black | 1 810,00 zł
295100698 · White | 1 810,00 zł



- All the benefits of LinQ—simple, fast and secure.
- Rotomolded construction for exceptional rigidity and durability.
- Premium-quality foam insulation for optimal ice retention.
- Uses LinQ mounting system (Patent US 8777531 and US 8875830).
- Easy one-second on/off tool-less system.
- Can contain twenty 355 ml cans.
- Keeps ice cold for three days.
- Exterior dimensions: 13" L x 20" W x 10" H.
- Interior dimensions : 9" L x 17" W x 7" H.
- Can't be installed on the rear lid due to weight limitation.
- See table for installation location and requirements.

Cennik zawiera sugerowane ceny detaliczne brutto w walucie PLN. Ceny mogą ulec zmianie bez wcześniejszego uprzedzenia.
 Cennik nie jest ofertą w rozumieniu prawa.

LinQ Tool Box	G3, G3L	715008111	822,00 zł
----------------------	---------	------------------	-----------



- High precision injected HDPE construction provides rigidity and durability.
- 5 gal (19 L) maximum capacity.
- Weather-resistant, sealed and lockable cover.
- Easy one-second on/off tool-less system.
- All the benefits of LinQ – simple, fast and secure.
- See table for installation location and requirements.

LinQ Roll-Top Bag	G3, G3L	715008110	1 053,00 zł
--------------------------	---------	------------------	-------------



- Fully waterproof roll-top dry bag will securely store and confine your equipment.
- LinQ mounted using heavy-duty rigid plastic base.
- High capacity storage solution 10.6 gal (40 L).
- Bottom foam liner for additional equipment protection.
- Integrated handle for easy transportation on/off the vehicle.
- Marinized for salt water purposes.
- Dimensions: 14" L x 19" W x adjustable H.
- See table for installation location and requirements.

SR 5.5 Gal (21 L) LinQ Bag	G3, G3L	860202449	1 053,00 zł
-----------------------------------	---------	------------------	-------------



- Semi-rigid expandable bag.
- 5.5 gal (21 L) capacity.
- See table for installation location and requirements.

LinQ 4.5 Gal (17 L) Sport Bag	G3, G3L	860202447	960,00 zł
--------------------------------------	---------	------------------	-----------



- All the benefits of LinQ – simple, fast and secure.
- 17 liter (4.5 US gallon) capacity.
- Thermoformed bag base in HDPE (High Density Polyethylene) providing rigidity and durability.
- Rigid bottom, semi-rigid top.
- Easy one-second on/off tool-less system.
- See table for installation location and requirements

LinQ Accessories with 36" Base

NEW LinQ Trunk Box (145 L)	G3, G3L (except MAX models)	715009471	3 140,00 zł
-----------------------------------	-----------------------------	------------------	-------------



- Polyethylene Trunk Box replacing the rear rack for perfect integration and to increase cargo capacity.
- Storage capacity of 31 gal (145 L).
- Easy to install and remove with the LinQ system.
- LinQ anchors must be installed in the rear cargo compartment (4 LinQ anchors included).
- Possibility to install LinQ 16" accessories on the cover to increase the cargo capacity.
- New ergonomic and resistant latch system offers excellent sealing.
- Ability to install LinQ Tool Holders (715008896) on the box.
- Lockable with a lock on the front of the box (two keys included).

NEW LinQ Trunk Box (139 L)	G3, G3L (MAX models only)	715009472	3 140,00 zł
-----------------------------------	---------------------------	------------------	-------------



- Polyethylene Trunk Box replacing the rear rack for perfect integration and to increase cargo capacity.
- Storage capacity of 30 gal (139 L).
- Easy to install and remove with the LinQ system.
- LinQ anchors must be installed in the rear cargo compartment (4 LinQ anchors included).
- Compatible with the passenger seat.
- New ergonomic and resistant latch system offers excellent sealing.
- Ability to install LinQ Tool Holders (715008896) on the box.
- Lockable with a lock on the front of the box (two keys included).

NEW LinQ Trunk Box (87 L) – G3L	G3L	715009312	2 417,00 zł
--	-----	------------------	-------------



- Weatherproof Polyethylene Rear Cargo Box.
- Can be installed on the rear rack only.
- Storage capacity of 23 gal (87 L).
- Optimized shape of the cargo box base to fit perfectly the G3L rear rack.
- Lockable with a lock on the front of the box (2 keys included).
- Easy to install, easy to remove using the LinQ system.
- Installation in LinQ 36" configuration.
- Compatible with the passenger seat.
- Ability to install LinQ Tool Holders (715008896) on the box.

Cennik zawiera sugerowane ceny detaliczne brutto w walucie PLN. Ceny mogą ulec zmianie bez wcześniejszego uprzedzenia.
Cennik nie jest ofertą w rozumieniu prawa.

NEW LinQ Trunk Box (87 L) – G3	G3	715009499	2 417,00 zł
---------------------------------------	----	------------------	-------------



- Weatherproof Polyethylene Rear Cargo Box.
- Can be installed on the rear rack only.
- Storage capacity of 23 gal (87 L).
- Optimized shape of the cargo box base to fit the G3L rear rack perfectly.
- Lockable with a lock on the front of the box (2 keys included).
- Easy to install, easy to remove using the LinQ system.
- Installation in LinQ 36" configuration.
- Compatible with the passenger seat.
- Ability to install Tool Holders (715008896) on the box.

NEW LinQ Cargo Box (90L)	G3, G3L (except X mr)	715005272	2 279,00 zł
---------------------------------	-----------------------	------------------	-------------



- Made of polyethylene.
- Storage capacity of 23 gal (90 L).
- Can be installed on the front rack only.
- Easy to install, easy to remove using the LinQ system.
- Need to remove the front DropDown cover for optimal capacity.
- Lockable with a lock on the front of the box (2 keys included).

LinQ Cargo Box (53 L)	G3	715010172	1 822,00 zł
	G3L	715006997	1 822,00 zł



- Made of polyethylene.
- Storage capacity of 14 gal (53 L).
- Easy to install and remove with the LinQ system.
- Can be installed on the front or rear racks.
- New ergonomic and resistant latch system offers excellent sealing.
- Possibility to install LinQ 16" accessories on the cover and increase the cargo capacity.
- Ability to install LinQ Tool Holders (715008896) on the box.
- Lockable with a lock on the front of the box (two keys included).

LinQ Low Profile Box (63 L)	G3, G3L	715007827	1 822,00 zł
------------------------------------	---------	------------------	-------------



- Made of impact-resistant injected polypropylene and weatherproof, this box has a storage capacity of 16.6 gal (63 L).
- LinQ-mounted for efficient and secure storage, it is locked in place with only a quarter turn. Easy to install, easy to remove using the LinQ system.
- Can be installed in a 36" configuration only.
- LinQ 16" accessories can be installed on the cover to increase cargo capacity.
- Easily carried with the rigid handle. The anti-vibration system prevents the handle from moving while riding.
- Support feet at hinge level so the box can stand on its own.
- The compact design allows for maximum rear field of vision.
- Features a lock on the front of the box (two keys included).

LinQ Cargo Basket (90 L)	G3	715010173	1 174,00 zł
	G3L	715005274	1 174,00 zł



- Made of polyethylene.
- Storage capacity of 23 gal (90 L).
- Easy to install and remove with the LinQ system.
- Can be installed on the front or rear racks.
- Six handles on the contour to easily install bungee cords.
- Ability to install LinQ Tool Holders (715008896) to the basket.

Large Cargo Box	G3L	715007001	3 128,00 zł
------------------------	-----	------------------	-------------



- Rear bed to carry large items.
- Anchor points (D-ring), LinQ fixtures for tool holder, and marks to allow the installation of a 16" accessory.
- Also has a mat for the floor and slot to enable the installation of a divider and a slot for a divider to close the recess on the rear vertical lip.
- It is installed on ATV platforms through the LinQ system and hooks to make it easily installable and removable.

Installation of some accessories shown may impact vehicle compliance with some regulations. Consult your local dealer for information.

LinQ 9.2 Gal (35 L) Cooler	G3, G3L	715006998	3 163,00 zł
-----------------------------------	---------	------------------	-------------



- LinQ-mounted for efficient and secure storage, locked in place with only a quarter turn.
- Easy to install, easy to remove using the LinQ system.
- Installation in LinQ 36" configuration.
- Made of polyethylene for exceptional rigidity and durability.
- Storage capacity of 9.2 gal (35 L).
- Lock the cooler on the vehicle using the LinQ Lock (860201968).
- Premium-quality foam insulation for optimal ice retention.
- Option to add a 5-slot LinQ Lite Rail on the side and at the rear of the cooler.
- A dry basket is included to protect your food from water.
- Drain plug at the bottom to get rid of excess water.
- The new ergonomic and resistant latch system ensures the top is tightly sealed.
- Innovative way to hold 12 cans (355 ml).
- Molded-in handles for quick installation and removal.

Cennik zawiera sugerowane ceny detaliczne brutto w walucie PLN. Ceny mogą ulec zmianie bez wcześniejszego uprzedzenia.
Cennik nie jest ofertą w rozumieniu prawa.

NEW LinQ Front Rack Extension | G3 (except X mr models) | **715009281** | 1 272,00 zł



- Easy to install and remove with the LinQ system.
- Fits front of the vehicle only.
- Provides tie-down points to secure cargo on racks.
- Made of aluminum with durable powder-coat finish.
- Height of 5".

NEW LinQ Rear Rack Extension | G3 (except X mr models) | **715009475** | 1 469,00 zł

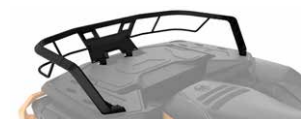

- Easy to install and remove with the LinQ system.
- Fits rear of the vehicle only.
- Provides tie-down points to secure cargo on racks.
- Made of aluminum with durable powder-coat finish.
- Height of 7".

LinQ Rack Extension | G3L | **715004954** | 983,00 zł



- Easy to install and remove with the LinQ system.
- Fits front or rear of the vehicle.
- Provides tie-down points to secure cargo on racks.
- Made of steel with anti-corrosion coating and durable powder-coat finish.
- Height of 7".

LinQ Holders

LinQ Tool Holder | G3, G3L | **715007358** | 294,00 zł



- Ultra-versatile tool holder.
- Convenient swivel-latch allows tools to be stored in any orientation.
- Sold in pairs.

LinQ Gear Grips | G3, G3L | **715005340** | 793,00 zł



- Durable and flexible grips provide a custom fit for a variety of items from 1" to 4" (2.5 cm to 10 cm) in diameter.
- Heavy-duty design for carrying bows, fishing poles, rakes, farm tools and more.
- Quick-release button opens grip quickly for easy access to gear.
- Heavy-duty base system built for the toughest adventures.
- Make transporting your tools a snap by combining the Gear Grips with the LinQ system.
- 360° orientation.
- Sold in pairs.

LinQ Gear Grips | G3L | **715001421** | 492,00 zł



- Durable, flexible grips cushion and protect while providing a custom fit for a variety of items from 1" to 4" (2.5 cm to 10 cm) in diameter.
- Heavy-duty design for carrying bows, fishing poles, rakes, farm tools and more.
- Quick-release button opens grip quickly for easy access to gear.
- Heavy-duty base system built for the toughest adventures.
- Easy installation on tubular racks, extension racks, brackets or bumpers.
- Sold in pairs.

LinQ Gun Case | G3, G3L | **715009240**



- The practical design lets riders store shotguns and rifles up to 52" (132 cm), even with most optic configurations.
- Adapts to different weapon shapes and features with foam cushions that can be repositioned.
- The Gun Case is LinQ-mounted for efficient and secure storage, and is locked in place with only a quarter turn.
- The LinQ Gun Case must be installed on the front compartment lid using the LinQ Base Installation Kit (860201806), on the Front Rack or on fender position using the LinQ Gun Case Mounting Kit (715006074).
- Can't be installed on the rear lid due to weight limitation.

LinQ Gun Case Mounting Kit - Fender Position | G3, G3L | **715006074** | 636,00 zł



- This kit is required to install the LinQ Gun Case on fender position.
- Installs on the right side of the vehicle, and the safety system allows the driver or passenger to quickly exit the vehicle.
- The low-profile mounting system can be left on the vehicle year-round and doesn't get in the way when the Gun Case is not installed.

Cennik zawiera sugerowane ceny detaliczne brutto w walucie PLN. Ceny mogą ulec zmianie bez wcześniejszego uprzedzenia.
Cennik nie jest ofertą w rozumieniu prawa.

Holders

Tool Holder Bolt-On	G3, G3L	715008896	222,00 zł
----------------------------	---------	------------------	-----------



- Tool Holder is made to fit the LinQ Cargo Basket (90 L) (715005274), LinQ Cargo Box (53 L) (715006997), LinQ Trunk Box (139 L) (715006097 & 715009472) and LinQ Trunk Box (145 L) (715005273 & 715009471).
- Convenient swivel-latch allows tools of all shapes to be stored in the proper orientation.
- Sold in pairs.
- Several degrees of adjustment.

Multi-Fit Holder	G3L	715002354 · Single	309,00 zł
		715001945 · Double	492,00 zł



- Open U-shaped bracket for carrying tools (shovel, axe) and hunting weapons (rifle, bow) that are safely secured, but easily accessible.
- Easy installation on tubular rack, extension racks, basket or bumpers.
- Sold in pairs.

LinQ Mounting

LinQ Base Installation Kit	G3, G3L	860201806	192,00 zł
-----------------------------------	---------	------------------	-----------



- Unique mounting fastener usable on any LinQ system accessory.
- Included: 2 cargo LinQ bases and hardware.

LinQ Base	G3L	715002350	121,00 zł
------------------	-----	------------------	-----------



- Made of polypropylene glass fiber.
- Allows you to install LinQ accessories.
- Sold in pack of 4.

LinQ Lock	G3, G3L	860201968	305,00 zł
------------------	---------	------------------	-----------



- Simple way to securely lock most LinQ accessories.
- Lock cover protects lock from the elements.
- Corrosion resistant.
- Pack of 1, includes 2 keys.
- Not compatible with LinQ 4.2 US Gal (16 L) Cooler, LinQ Tool Box, LinQ Tool Holder and LinQ Gear Grips.

CARGO & STORAGE

Soft Storage Bag (70 L)	G3, G3L	715007002	1 007,00 zł
--------------------------------	---------	------------------	-------------



- Carry your gear in a weatherproof bag.
- Soft bag with a storage capacity of 18.5 gal (70 L) designed to maximize space in the front or rear of the vehicle.
- 3-compartment bag with removable dividers.
- Easy to install with strap system.
- X mr models: Fits on rear rack only.

CAN-AM WINDSHIELDS

NEW Adventure High Windshield – Hardcoated	G3 (except X mr models)	715009458	1 614,00 zł
---	-------------------------	------------------	-------------



- Quickly change your wind protection with the flip of both levers.
- 14" (36 cm) high to protect against wind and winter weather with a 2" (5 cm) adjustment.
- Made of injected polycarbonate with a thickness of 1/2" (4 mm) with ultra-resistant Quantum¹ coating.
- Provides excellent optical clarity and better abrasion resistance.
- Console Extension (715009218) is required for installation.
- Side Wind Deflectors (715009462) available for added protection.

Installation of some accessories shown may impact vehicle compliance with some regulations. Consult your local dealer for information.

Cennik zawiera sugerowane ceny detaliczne brutto w walucie PLN. Ceny mogą ulec zmianie bez wcześniejszego uprzedzenia.

Cennik nie jest ofertą w rozumieniu prawa.

Adventure High Windshield – Hardcoated	G3L (except X mr models)	715007268	1 226,00 zł
---	--------------------------	------------------	-------------



- Adventure windshield with three-position adjustable height.
- 14" (36 cm) high to protect against wind and winter weather.
- Made of injected polycarbonate with a thickness of 5/32" (4 mm) with ultra-resistant Quantum⁺ coating.
- Provides excellent optical clarity and better abrasion resistance.
- Console Extension (715005368) is required for installation.
- Side Wind Deflectors (715005862) available for added protection.

Installation of some accessories shown may impact vehicle compliance with some regulations. Consult your local dealer for information.

NEW Adventure High Windshield	G3 (except X mr models)	715009453	1 324,00 zł
--------------------------------------	-------------------------	------------------	-------------

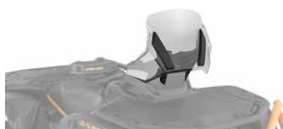

- Quickly change your wind protection with the flip of both levers.
- 14" (36 cm) high to protect against wind and weather with a 2" (5 cm) adjustment.
- Made of injected polycarbonate with a thickness of 5/32" (4 mm).
- Console Extension (715009218) is required for installation.
- Side Wind Deflectors (715009462) available for added protection.

Installation of some accessories shown may impact vehicle compliance with some regulations. Consult your local dealer for information.

Adventure High Windshield	G3L (except X mr models)	715005377	983,00 zł
----------------------------------	--------------------------	------------------	-----------



- Adventure windshield with three-position adjustable height.
- 14" (36 cm) high to protect against wind and weather.
- Made of injected polycarbonate with a thickness of 5/32" (4 mm).
- Console Extension (715005368) is required for installation.
- Side Wind Deflectors (715005862) available for added protection.

Installation of some accessories shown may impact vehicle compliance with some regulations. Consult your local dealer for information.

NEW Ajustable Adventure Low Windshield	G3 (except X mr models)	715009219	1 226,00 zł
---	-------------------------	------------------	-------------



- Quickly change your wind protection with the flip of both levers.
- 10" (25 cm) high for wind protection with a 2" adjustment.
- Made of injected polycarbonate with a thickness of 5/32" (4 mm).
- Console Extension (715009218) is required for installation.
- Side Wind Deflectors (715009462) available for added protection.

Installation of some accessories shown may impact vehicle compliance with some regulations. Consult your local dealer for information.

Adventure Low Windshield	G3L (except X mr models)	715005860	885,00 zł
---------------------------------	--------------------------	------------------	-----------



- Adventure windshield with three-position adjustable height.
- 10 in. (25 cm) high for wind protection.
- Made of injected polycarbonate with a thickness of 5/32" (4 mm).
- Console Extension (715005368) is required for installation.
- Side Wind Deflectors (715005862) available for added protection.

Installation of some accessories shown may impact vehicle compliance with some regulations. Consult your local dealer for information.

NEW Adventure Side Wind Deflectors	G3 (except X mr models)	715009462	636,00 zł
---	-------------------------	------------------	-----------

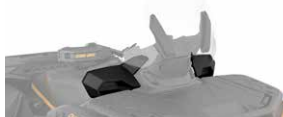

- Side Wind Deflectors for additional wind protection.
- Easy installation.
- Controllable vents to manage airflow.
- Console Extension (715009218) is required for installation.
- Works with Adventure Windshields (715009219, 715009453, 715009458).
- Not compatible with Integrated Audio System (715005354).

Adventure Side Wind Deflectors	G3L (except X mr models)	715005862	636,00 zł
---------------------------------------	--------------------------	------------------	-----------



- Side Wind Deflectors for additional wind protection.
- Easy installation.
- Console Extension (715005368) is required for installation.
- Works with Adventure Windshields (715005860, 715005377, 715007268).
- Not compatible with Integrated Audio System (715005354).

Cennik zawiera sugerowane ceny detaliczne brutto w walucie PLN. Ceny mogą ulec zmianie bez wcześniejszego uprzedzenia.
Cennik nie jest ofertą w rozumieniu prawa.

NEW Console Extension

G3 (except X mr models)

715009218

914,00 zł



- Integrated storage compartment (2 L) with magnetic mount safe for your electronic device.
- Robust injected fiber-reinforced-polypropylene construction makes it easy to fit and install.
- 25 times stronger than any smartphone's weight, so you can ride through rough terrain confidently.
- Two possible positions for your electronic device: portrait and landscape.
- Includes everything needed for installation on your favorite electronic devices: one pre-assembled Can-Am plate with 3M multi-surface adhesive.
- Includes guide clips molded into the door to feed the charging cable.
- Possibility of installing USB outlet in storage compartment (USB power outlet sold separately).
- Required for the installation of the Adventure Windshield and Side Wind Deflectors.
- Not compatible with Snorkel Kit.
- Includes tether cord for additional peace of mind.

Console Extension

G3L (except X mr models)

715005368

983,00 zł



- Integrated storage compartment (1 gal/4 L) with magnetic mount safe for your electronic device.
- Robust injected fiber-reinforced-polypropylene construction makes it easy to fit and install.
- 25 times stronger than any smartphone's weight, so you can ride through rough terrain confidently.
- Two possible positions for your electronic device: portrait and landscape.
- Includes everything needed for installation on your favorite electronic devices: two pre-assembled Can-Am plates with 3M multi-surface adhesive.
- Includes guide clips molded into the door to feed the charging cable.
- Possibility of installing USB outlet in storage compartment (USB power outlet sold separately).
- Required for the installation of the Adventure windshield and side wind deflectors.
- Not compatible with Snorkel Kit.
- Includes tether cord for additional peace of mind.

Console Extension USB Power Outlet

G3, G3L (except X mr models)

715008750

371,00 zł



- Useful for the Console Extension (715005368 & 715009218) to plug your electronic device charger into the compartment.
- USB-A and USB-C ports.
- Rubber cap protects ports when not in use.
- Backlit to highlight the USB ports.
- Console Extension (715005368 or 715009218) is required for installation.

HANDLEBARS & MIRRORS

Driver Full Wrap Handguards

G3, G3L

■ **715005361** · Black

735,00 zł

■ **715005362** · Neo Yellow

689,00 zł



- Protects against wind, branches and debris.
- Rugged injected plastic deflectors with Can-Am logo.
- Lightweight black die cast aluminum full wrap frame.
- New ergonomic design offers better comfort for the hand and increases protection.
- Mounting system leaves the handlebar free.
- Includes complete hardware.

Passenger Wind Deflectors

G3, G3L (MAX models only)

715001669

457,00 zł



- These wind deflectors fit on the passenger handles and provide greater comfort while riding.
- Easy to install and remove.

Handlebar Mirrors

G3, G3L

715005366

343,00 zł



- Adjustable handlebar mounted convex mirrors.
- The convex surface allows improved visibility with a wider field of view.
- Doesn't require a windshield or fairing to be mounted.
- Works with all windshield options.

Cennik zawiera sugerowane ceny detaliczne brutto w walucie PLN. Ceny mogą ulec zmianie bez wcześniejszego uprzedzenia.
Cennik nie jest ofertą w rozumieniu prawa.

SKID PLATES

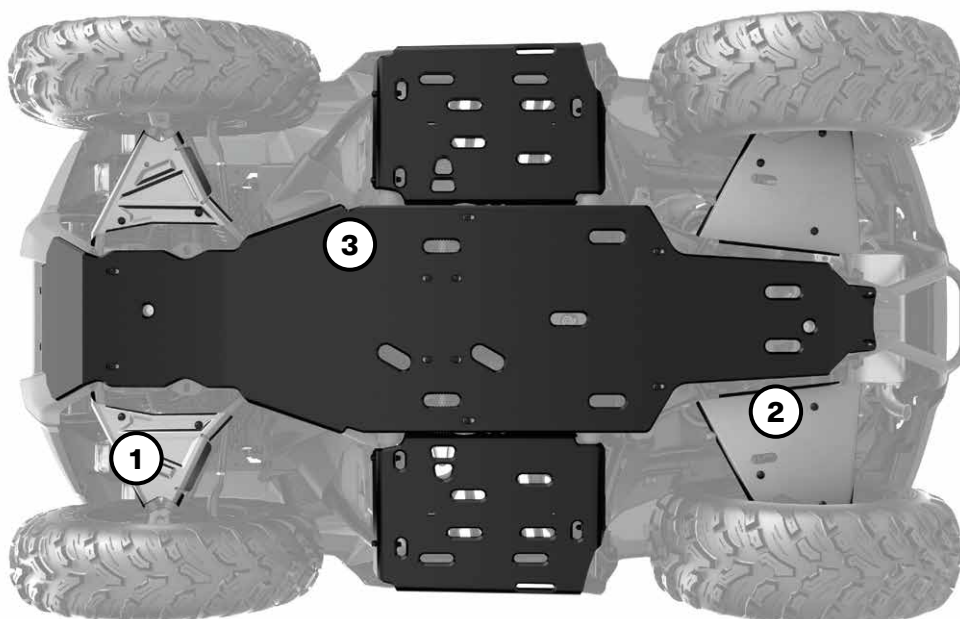

Our Skid Plates deliver the durability, strength, and reliability your adventures need. Protect the underbelly of your vehicle from front to rear, with folded ends at the footwells for a little extra. They combine materials for peak protection: with aluminum A-arms and a plastic underbelly, your ride can drive across rough terrain confidently.

- Quick and easy, bolt-on installation. No need to remove factory skid plates. No more rivets or rivnuts.
- Thicker underbelly plates (10 mm).

OUTLANDER

G3		G3L	
2025		2023 and up	
Except MAX models	MAX models only	Except MAX models	MAX models only

Skid Plate Protection Kit

715009216	715009217	715005309	715005310
-----------	-----------	-----------	-----------

Individual Skid Plates

① Front Aluminum A-Arm Protectors	715009214	715009214	715005305	715005305
② Rear Aluminum A-Arm Protectors	715009215	715009215	715005308	715005308
③ HMWPE Underbelly Plates	715009864	715009865	715005306	715005307

Cennik zawiera sugerowane ceny detaliczne brutto w walucie PLN. Ceny mogą ulec zmianie bez wcześniejszego uprzedzenia.
Cennik nie jest ofertą w rozumieniu prawa.

BUMPERS & GUARDS

Bumpers

XU Front Bumper	G3L	715006614	1 567,00 zł
------------------------	-----	------------------	-------------



- Heavy-duty tubular construction provides the most complete protection for your vehicle.
- Protects vehicle lights and corners.
- Winch compatible.
- Integrated tow hook.
- Similar to the XU model's bumper.

XT Front Bumper	G3L	715004952	833,00 zł
------------------------	-----	------------------	-----------



- Provides additional protection for your vehicle against the elements.
- Tough and durable.
- Large tube construction with black powder coat finish.
- Similar to stock bumper on XT models.
- Mounting plate included for tow hook.

NEW Extreme Front Bumper Plates	G3 (except X mr models)	715009293	735,00 zł
--	-------------------------	------------------	-----------



- Ultra-robust steel construction provides additional protection to the front of the vehicle in rough terrain.
- Compatible with all front bumpers.
- Durable powder coat finish.
- Not compatible with track systems.

Installation of some accessories shown may impact vehicle compliance with some regulations. Consult your local dealer for information.

Extreme Front Bumper Plate	G3L (except X mr models)	715005439	735,00 zł
-----------------------------------	--------------------------	------------------	-----------

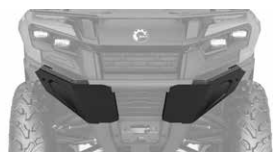

- Ultra-robust construction provides additional protection to the front of the vehicle in rough terrain.
- Compatible with all front bumpers.
- Not compatible with track systems.

Installation of some accessories shown may impact vehicle compliance with some regulations. Consult your local dealer for information.

Front Tow Hook	G3L	715008842	222,00 zł
-----------------------	-----	------------------	-----------



- Provides a solid anchor when towing is needed or when transporting the vehicle.
- Allows you to attach most hooks or straps.
- This tow hook offers 3,500 lb (1,587 kg) of towing capacity.
- Made of forged steel.
- XT Front Bumper (715004952) required for installation.
- Not compatible with Outlander XT stock bumper.

Full Rear Bumper	G3L	715008738	1 076,00 zł
-------------------------	-----	------------------	-------------



- Provides additional protection for your vehicle against obstacles.
- Protects the rear lights of the vehicle without obstructing them.
- Strong and durable, it must be added to the XT rear bumper (stock or accessory) for full protection.
- Wide and sturdy tubular construction with black powder-coat finish and metal corners.

XT Rear Bumper	G3L (STD, DPS & X mr models only)	715004953	636,00 zł
-----------------------	-----------------------------------	------------------	-----------



- Sturdy tubular construction.
- Protects the vehicle against obstacles.
- Standard on Outlander XT and Outlander PRO.
- Fits base models with grab bar only.
- Required to install the Full Rear Bumper.

Cennik zawiera sugerowane ceny detaliczne brutto w walucie PLN. Ceny mogą ulec zmianie bez wcześniejszego uprzedzenia.
Cennik nie jest ofertą w rozumieniu prawa.

Guards

Fender Flares	G3L (except T-cat models)	715005349	636,00 zł
	G3L (T-cat models only)	715006336	492,00 zł



- Kit is designed to deliver extra protection to your vehicle from dirt and debris. If you enjoy riding in the mud, it's a must.
- Made of injected plastic that hugs your vehicle fenders perfectly.
- Gives vehicle added flair for a rugged, cool look.
- Includes front and rear extensions and all mounting hardware.

LIGHTS & ELECTRICAL

Integrated Heated Grips & Thumb Throttle Combo	G3, G3L except LTD	715005072	1 585,00 zł
---	--------------------	------------------	-------------



- Heat levels for grips and thumb displayed on vehicle screen.
- Ergonomic button integrated on LH grip.
- Single button for both grips and thumb heat selection.
- Five temperature settings for the thumb and grips.
- Adjustable heat ratio between grip and thumb warmer.
- Hold button to reach maximum heat quickly.
- Remembers your last heat setting.
- IP67-rated waterproof sealing keeps the elements out.
- ECE compliant.
- Plug-and-play installation.
- Clamp-on grips, no glue required.

Heated Passenger Grips & Visor Outlet	G3 (MAX models only), G3L (MAX models only)	715005358	1 845,00 zł
--	--	------------------	-------------

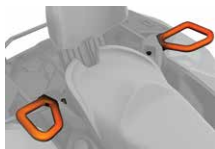

- Replace your stock passenger handles.
- Dual temperature switch integrated into seat arm for 3-zone heated handles and grips.
- Heated visor outlet integrated into seat arm.

Seat Heater	G3, G3L	715007211	712,00 zł
--------------------	---------	------------------	-----------



- 25 W seat heater delivers chill-free riding comfort.
- One temperature only.
- Heated pad and electrical harness only.
- Heavy-Duty Seat Cover (715008311) is required for installation on 1-up models.
- Heavy-Duty Seat Cover (715008313) is required for installation on 2-up models.

Heated Visor Outlet	G3, G3L	715001246	301,00 zł
----------------------------	---------	------------------	-----------



- Strategically positioned on vehicle to maintain your agility.
- Optional visor outlet that delivers fog-free riding.
- Quick and easy installation.
- Sold individually.
- Heated Visor not included.

NEW USB Power Outlet Kit	G3, G3L	219400510	211,00 zł
---------------------------------	---------	------------------	-----------



- Recharges your electronic devices while riding* (smartphone, MP3, heating gear, etc.).
- Dual port USB connectors.
- Plug-and-play kit.





*The power outlet is not capable of recharging all device types while riding.

USB Intelligent Power Outlet Kit	G3, G3L	715009117	316,00 zł
---	---------	------------------	-----------



- Power all your electronics with this easy-to-mount USB plug.
- Provides one USB-A3.0 and one USB C (PD) plug.
- Power rate: 36 watts.
- Intelligent USB charger for a fast charge when battery is low.
- Replaces the vehicle's 12 V socket.

Cennik zawiera sugerowane ceny detaliczne brutto w walucie PLN. Ceny mogą ulec zmianie bez wcześniejszego uprzedzenia.
Cennik nie jest ofertą w rozumieniu prawa.

Cellphone Holder	G3, G3L	715008786	527,00 zł
	<ul style="list-style-type: none"> • Water resistant door allows for perfect phone positioning. • Features capacitive and resistive touch screen technology. • Spring system in back plate automatically adjusts for thickness. • Fits all cellphones within 7.2" (185 mm) x 3.3" (85 mm) x 0.6" (15 mm) dimensions. • Works with almost all charger wires. • Does not include cellphone or charging wires. <ul style="list-style-type: none"> • Requires the GPS RAM Mount for Handlebar (715001985) or the Console Extension (715005368) for installation. • If installed on the Console Extension, the Console Extension USB Power Outlet (715008750) is required to charge cellphone. • If installed on the Console Extension, Driver Full Wrap Handguards (715005361 or 715005362) are incompatible. 		
GPS RAM[†] Mount for Handlebar	G3, G3L	715001985	371,00 zł
	<ul style="list-style-type: none"> • Convenient bracket for installing the Garmin Montana GPS (715002830) or the Cellphone Holder (715008786) (not included) onto your unit's handlebar. 		
Integrated Audio System	G3, G3L	715005354	4 637,00 zł
	<ul style="list-style-type: none"> • Fully integrated and weatherproof audio system. • Includes two 6.5" front fender Bluetooth speakers giving you fingertip control of the tracks you're playing. • Designed to be Can-Am tough in the most demanding riding conditions. • Expertly tuned for exceptional sound, even when you're on the move on your Outlander. • Comes with two speakers, each with 50 W dynamic power, for a total of 100 W dynamic power. • Seamless integration and operation from any Bluetooth-enabled devices, or via an auxiliary port. <ul style="list-style-type: none"> • Plug-and-play audio system specifically designed not to drain the battery. • Compatible with the Console Extension (715005368 or 715009218) and Adventure Windshields. • Not compatible with the Adventure Side Wind Deflectors (715005862 or 715009462). • EC compliant. <p><i>Note: We recommend you use 20 kbps MP3, 192-256 kbps AAC or AIFF, WAV formats to match the potential of the speaker. More compressed formats will probably have degraded sound quality.</i></p>		
Bluetooth Handlebar Soundbar by MTX	G3, G3L	219400840	2 579,00 zł
	<ul style="list-style-type: none"> • Bluetooth speaker with the unbeatable convenience of fingertip control. • Rugged IP66-rated weather-resistant speaker designed for outdoor use. • Driven by 150 watts of quality audio power. • Seamless integration and operation from Bluetooth enabled devices. <ul style="list-style-type: none"> • Includes input, ground and ignition wires, plus auxiliary port and 3.5" (8.89 cm) connector cable. • Not compatible with XT Handlebar Protector Kit. • EC compliant. <p><i>Note: We recommend you use 320 kbps MP3, 192-256 kbps AAC or AIFF, WAV formats to match the potential of the speaker. More compressed formats will probably have degraded sound quality.</i></p>		
3.5" (9 cm) LED Lights (2 X 14 W) LED Driving Lights	G3, G3L (except X mr models)	715009775	1 190,00 zł
	<ul style="list-style-type: none"> • 14 W LED lights producing 1,260 lumens each. • Equipped with 6 high power LEDs in a heavy-duty die cast aluminum housing. • Features 2 attachment points — if one attachment point fails due to a collision, rotate to the next channel point and re-mount the light. • Sold in pairs. <ul style="list-style-type: none"> • ECE certified. • Spot lens for a narrow and long light beam spread, ideal when driving at higher speeds. • XT or XU Front Bumpers (715004952 and 715006614) and Light Power Cable (715005353) required for installation. • Can also be installed on the stock front bumpers (XT and XU). 		
3.5" (9 cm) LED Lights (2 X 14 W) LED Flood Lights	G3L (except X mr models)	715009774	1 190,00 zł
	<ul style="list-style-type: none"> • 14 W LED lights producing 1,260 lumens each. • Equipped with 6 high power LEDs in a heavy-duty die cast aluminum housing. • Features 2 attachment points — if one attachment point fails due to a collision, rotate to the next channel point and re-mount the light. • Sold in pairs. • ECE certified. <ul style="list-style-type: none"> • Flood lens for a wide light beam spread, ideal for working applications like plowing or for cornering, dusty or foggy riding conditions. • XT or XU Front Bumpers (715004952 and 715006614) and Light Power Cable (715005353) required for installation. • Can also be installed on the stock front bumpers (XT and XU). 		
10" (25 cm) Double Stacked LED Light Bar (60 W)	G3, G3L (except X mr models)	715002933	1 659,00 zł
	<ul style="list-style-type: none"> • Equipped with 12.5 W Cree LEDs. • 5,400 lumens. • Rugged and waterproof. • Packs a big punch for its size. <ul style="list-style-type: none"> • Not EC compliant. • XT or XU Front Bumpers (715004952 and 715006614) and Light Power Cable (715005353) required for installation. • Can also be installed on the stock front bumpers (XT and XU). 		

Cennik zawiera sugerowane ceny detaliczne brutto w walucie PLN. Ceny mogą ulec zmianie bez wcześniejszego uprzedzenia.
Cennik nie jest ofertą w rozumieniu prawa.

15" (38 cm) Double Stacked LED Light Bar (90 W) G3, G3L (except X mr models) **715002934** 2 035,00 zł



- Equipped with 18 5 W Cree LEDs. 8,400 lumens.
- Complements the Light Racks and most bumpers.
- Rugged and waterproof.
- Lights up to more than 1,900 ft (580 m) in front of the vehicle and around 65 ft (20 m) wide on each side.
- Not EC compliant.
- XT Front Bumper (715004952) and Light Power Cable (715005353) are required for installation.
- Can also be installed on the stock front bumpers (XT only).

Light Power Cable
(Not illustrated) G3, G3L **715005353** 252,00 zł

- Required for installation of the 10" (25 cm) and 15" (38 cm) LED Light Bars, as well as the 3.5" (9 cm) LED Lights.

RAM[†] LED Spotlight G3, G3L **710005423** 777,00 zł



- 540 lumen LED light (9 W) heavy-duty spotlight standard-equipped with 1" (2.5 cm) diameter rubber-coated double ball and socket system.
- Installation of some accessories shown may impact vehicle compliance with some regulations. Consult your local dealer for information.*

NEW RFID Key Green DESS G3, G3L **710005232** 322,00 zł



- Top-security anti-theft protection for your vehicle.
- Encrypted chip technology restricts access to your vehicle's electronic ignition system.
- One vehicle/one code.
- A vibration/shock-resistant ball-and-socket design that ensures a reliable connection.
- 3 programmable modes:
Work mode: Limits vehicle speed to 40 kph (25 mph) but does not limit engine torque.
Normal mode: Limits vehicle speed to 70 kph (44 mph) and 50% torque reduction.
Performance mode: No restrictions.

C-TEK charger **860200997** 567,00 zł



- CTEK, the manufacturer of the smartest battery chargers in the world, has produced a BRP specific charger for all BRP products.
- Charger is built to meet the demanding arctic conditions.
- Ask your dealer for more information.

WINCHES

Can-Am HD Winches

NEW Can-Am HD 2500 Winch G3 (except X mr) G3L (2025 & up) **715009797** 1 949,00 zł



- Ergonomic clutch handle.
- Rugged all-steel gears and bushings for more torque and longer life.
- Automatic 100% load-holding brake.
- Corded 10 ft. (3 m) weather sealed wired remote control (sold separately).
- Pulling strength capability of 2,500 lb (1,134 kg).
- 50 ft. of 3/16" (15.2 m of 4.8 mm) wire steel cable.
- Heavy-duty 4-way roller fairlead.
- Weather-sealed handlebar-mounted switch.
- Sealed solenoid for all-weather protection.
- Plug-and-play wiring.
- EC & UKCA compliant.

NEW Can-Am HD 3500 Winch G3 (except X mr) G3L (2025 & up) **715009798** 2 111,00 zł



- Ergonomic clutch handle.
- Rugged all-steel gears and bushings for more torque and longer life.
- Automatic 100% load-holding brake.
- Corded 10 ft. (3 m) weather sealed wired remote control (sold separately).
- Pulling strength capability of 3,500 lb (1,588 kg).
- 50 ft. of 7/32" (15.2 m of 5.2 mm) wire steel cable.
- Heavy-duty 4-way roller fairlead.
- Weather-sealed handlebar-mounted switch.
- Sealed solenoid for all-weather protection.
- Plug-and-play wiring.
- EC and UKCA compliant.

Cennik zawiera sugerowane ceny detaliczne brutto w walucie PLN. Ceny mogą ulec zmianie bez wcześniejszego uprzedzenia.
Cennik nie jest ofertą w rozumieniu prawa.

Can-Am HD 2500 Winch	G3L 2024 & prior	715006973	1 754,00 zł
-----------------------------	------------------	------------------	-------------



- Ergonomic clutch handle.
- Rugged all-steel gears and bushings for more torque and longer life.
- Automatic 100% load-holding brake.
- Coded 10 ft. (3 m) weather sealed wired remote control (sold separately).

- 50 ft. of 3/16" (15.2 m of 4.8 mm) wire steel cable.
- Heavy-duty 4-way roller fairlead.
- Weather-sealed handlebar-mounted switch.
- Sealed solenoid for all-weather protection.
- Plug-and-play wiring.
- EC and UKCA compliant.

• Pulling strength capability of 2,500 lb (1,134 kg).

Can-Am HD 3500 Winch	G3L 2024 & prior	715006974	1 900,00 zł
-----------------------------	------------------	------------------	-------------



- Ergonomic clutch handle.
- Rugged all-steel gears and bushings for more torque and longer life.
- Automatic 100% load-holding brake.
- Coded 10 ft. (3 m) weather sealed wired remote control (sold separately).
- Pulling strength capability of 3,500 lb (1,588 kg).

- 50 ft. of 7/32" (15.2 m of 5.2 mm) wire steel cable.
- Heavy-duty 4-way roller fairlead.
- Weather-sealed handlebar-mounted switch.
- Sealed solenoid for all-weather protection.
- Plug-and-play wiring.
- EC and UKCA compliant.

Can-Am HD 3500-S Winch	G3L 2024 & prior	715008285	2 373,00 zł
-------------------------------	------------------	------------------	-------------



- Ergonomic clutch handle.
- Rugged all-steel gears and bushings for more torque and longer life.
- Automatic 100% load-holding brake.
- Coded 10 ft. (3 m) weather sealed, wired remote control (sold separately).
- Pulling strength capability of 3,500 lb (1,588 kg).

- 50 ft. of 3/16" (15.2 m of 4.8 mm) synthetic rope.
- Heavy-duty hawse fairlead.
- Weather-sealed handlebar-mounted switch.
- Sealed solenoid for all-weather protection.
- Plug-and-play wiring.
- EC and UKCA compliant.

NEW Can-Am HD 3500-S Winch	G3 (except X mr models), G3L 2025 & up	715009799	2 637,00 zł
-----------------------------------	--	------------------	-------------



- Ergonomic clutch handle.
- Rugged all-steel gears and bushings for more torque and longer life.
- Automatic 100% load-holding brake.
- Coded 10 ft. (3 m) weather sealed, wired remote control (sold separately).
- Pulling strength capability of 3,500 lb (1,588 kg).

- 50 ft. of 3/16" (15.2 m of 4.8 mm) synthetic rope.
- Heavy-duty hawse fairlead.
- Weather-sealed handlebar-mounted switch.
- Sealed solenoid for all-weather protection.
- Plug-and-play.
- EC and UKCA compliant.

Winch Accessories

Can-Am HD Wired Remote Control	Can-Am HD Winches	715008121	151,00 zł
---------------------------------------	-------------------	------------------	-----------



- This kit allows owners to add a handheld remote to their winch or a stock winch.
- Works with the handlebar-mounted switch.
- Wired Remote and Remote Socket included.
- 10 ft. wire.

Winch Accessories Kit	715002409	706,00 zł
------------------------------	------------------	-----------



- Get the most out of your winch.
- Double your pulling power, change your pulling direction and keep your winch in proper working order.
- Includes tree straps, snatch block, shackle and winching gloves.

Cennik zawiera sugerowane ceny detaliczne brutto w walucie PLN. Ceny mogą ulec zmianie bez wcześniejszego uprzedzenia.
Cennik nie jest ofertą w rozumieniu prawa.

HITCHES

Hitches

Front Receiver Hitch	G3, G3L	715004977	492,00 zł
-----------------------------	---------	------------------	-----------



- Installs easily. No drilling required.
- This hitch offers a 1,500 lb (680 kg) towing capacity.
- Allows you to maneuver your trailer easily in tight, confined areas.
- Hitch bar sold separately.

Rear Hitch Drawbar Kit	G3, G3L	715006230	492,00 zł
-------------------------------	---------	------------------	-----------



- Works on 2" (5 cm) standard receiver hitch.
- Offers a towing capacity of 3.8 kN (R = 750 kg).
- 50 mm Hitch Ball included.
- Forged steel.
- For European vehicles only.

Front and Rear Hitch Drawbar	G3, G3L	715008350	492,00 zł
-------------------------------------	---------	------------------	-----------



- Standard on 2" (5 cm) receiver hitch.
- It offers 1,650 lb (750 kg) of towing capacity.
- Hitch ball not included.
- Forged steel.

Installation of some accessories shown may impact vehicle compliance with some regulations. Consult your local dealer for information.

Hitch Accessories

Rubber Receiver Plug		705204503	63,00 zł
-----------------------------	--	------------------	----------



- Rubber cap for 2" (5 cm) hitch receiver.

PERFORMANCE

Performance

Snorkel Kit	G3L	715005073	1 862,00 zł
--------------------	-----	------------------	-------------

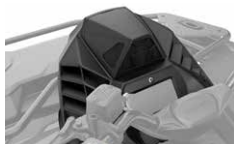

- Comprehensive snorkel kit for extended air intakes and CVT exhaust.
- The CVT outlet integrates into the pod cover.
- Ideal when riding in muddy conditions.
- Not compatible with windshields.
- Can be installed with the Integrated Audio System (715005354).

Installation of some accessories shown may impact vehicle compliance with some regulations. Consult your local dealer for information.

Radiator Relocator Kit	G3L	715004943	3 949,00 zł
-------------------------------	-----	------------------	-------------



- Relocates radiator to top mount position.
- Prevents cooling performance loss in muddy conditions.
- Allows riders to open the relocator hood for easy radiator cleaning.
- Engineered for easy cooling system bleeding and maintenance.
- Includes support, hardware and hoses. Uses existing radiator: radiator not included.

Installation of some accessories shown may impact vehicle compliance with some regulations. Consult your local dealer for information.

Cennik zawiera sugerowane ceny detaliczne brutto w walucie PLN. Ceny mogą ulec zmianie bez wcześniejszego uprzedzenia.

Cennik nie jest ofertą w rozumieniu prawa.

Mud Strap	G3, G3L	715003053	234,00 zł
------------------	---------	------------------	-----------



- Convenient sturdy grab-handle.
- Lets drivers redistribute their weight for improved traction in demanding conditions.

Radiator Protector	G3 (except X mr models) G3L (except X mr models)	715005333	492,00 zł
---------------------------	---	------------------	-----------



- Metal shield mounts over radiator face and protects vehicle from stones and branches.
- Easily slides out of its holder for easy cleaning.

Heavy Duty Spring Kits	G3L (except MAX & X mr models)	715008202 · Front 715004942 · Rear	735,00 zł 735,00 zł
-------------------------------	--------------------------------	---	------------------------



- Allows riders to replicate the standard HD5/HD7 suspension setup on the Outlander 500/700 (1-up).
- The heavy-duty springs improve handling and provide enhanced stiffness, which is perfect for snow clearing and hauling heavy loads.
- Two springs included in the kit.

Aluminum Footpeg Kit	G3, G3L	715008199	294,00 zł
-----------------------------	---------	------------------	-----------



- Provides maximum integrated grip and stability during vigorous riding.
- The kick-up end gives riders added grip during hard cornering.
- Made of aluminum, sold in pairs.

Emergency Accessories

Emergency Kit		715006102	787,00 zł
----------------------	--	------------------	-----------



- Complete emergency kit provides all essential equipment and supplies to get out of most unfavorable situations powersport enthusiasts may find themselves in.
- Includes jumper cables, air compressor, tire-repair kit, first-aid kit, ratchet tie-down, duct tape, 3,300 lb (1,500 kg) tow strap, zip-ties and cloth rags.

COVERS & ADD-ONS

Heavy-Duty Seat Cover	G3L (except MAX models)	715008311	294,00 zł
------------------------------	-------------------------	------------------	-----------



- Heavy-duty materials to cover and protect the seat.
- Designed to fit the vehicle's lines perfectly.
- Abrasion- and tear-resistant.
- Easily installed by stretching around the original seat: the elastic holds the cover securely in place.

Heavy-Duty Seat Cover	G3L (MAX models only)	715008313	394,00 zł
------------------------------	-----------------------	------------------	-----------



- Heavy-duty materials to cover and protect the seat.
- Designed to fit the vehicle's lines perfectly.
- Abrasion- and tear-resistant.
- Easily installed by stretching around the original seat: the elastic holds the cover securely in place.

Trailer Cover	G3, G3L (except MAX models)	715005074	1 122,00 zł
	G3, G3L (MAX models only)	715005075	1 122,00 zł





- Weather-resistant trailable cover protects your vehicle during storage and transportation.
- Heavy-duty canvas made of UV-resistant solution-dyed polyester.
- Inner soft liner protects windshield and colored panels from abrasion.
- Quick and easy clip-on installation.
- Designed with the vehicle to fit its lines perfectly for less wind resistance and less water accumulation.
- Can be installed with or without Can-Am accessories.

Cennik zawiera sugerowane ceny detaliczne brutto w walucie PLN. Ceny mogą ulec zmianie bez wcześniejszego uprzedzenia.
Cennik nie jest ofertą w rozumieniu prawa.

Flag	715000277 · Yellow	151,00 zł
	<ul style="list-style-type: none"> • Make sure everyone knows what you're riding. • Perfect for the dunes and new riders. • 8-ft. (2.4 m) length. • Includes Flag Mount (715000127). 	

Flag Mount <i>(Not illustrated)</i>	715000127	110,00 zł
---	------------------	-----------

Ratchet Tie-Downs	715008309 · Black/Gray	147,00 zł
	<ul style="list-style-type: none"> • 400 lb (181 kg) safe working load. • 1" x 10' (2.5 cm x 3 m) strap with Can-Am, Sea-Doo, and Ski-Doo logos. • Deluxe ratchet with rubber handle. • Coated S hooks. • Pack of 2. 	

Heavy-Duty Ratchet Tie-Down	715008308	219,00 zł
	<ul style="list-style-type: none"> • 1,000 lb (454 kg) safe working load. • 1.5" x 6' (38 mm x 1.8 m) strap with BRP brands. • Deluxe ratchet with rubber handle. • Black-coated clip hooks. • 12" (300 mm) webbing included. • Pack of two. 	

APACHE TRACK SYSTEMS

Apache Backcountry

Apache Backcountry Track System	G3, G3L	34 145,00 zł	715005247
	<ul style="list-style-type: none"> • Designed to deliver the best flotation level and deep-snow performance on the market. • Contact patch is 23% bigger than the Apache 360 LT. • Impressive added ground clearance of 7" (18 cm), keeps the vehicle out of deep snow. • Aggressive track design with 2" (5 cm) lug height for maximum traction on snow. • Apache Backcountry Mounting Kit and engine and air intake pre-filters are required. • For winter use only. <p><i>Installation of some accessories shown may impact vehicle compliance with some regulations. Consult your local dealer for information.</i></p>		

Apache Backcountry Mounting Kit <i>(Not illustrated)</i>	G3, G3L	3 392,00 zł	715010045
	<ul style="list-style-type: none"> • Required to install Apache Backcountry Track System. • DPS module and pre-filter not included. • Improved installation time and switch seasons faster than ever. <p><i>Installation of some accessories shown may impact vehicle compliance with some regulations. Consult your local dealer for information.</i></p>		

Apache XC and XC LT

NEW Apache XC LT Track System	G3, G3L (2023 & up)	34 927,00 zł	715007719
	<ul style="list-style-type: none"> • Long Track version. • Brand-new track design to optimize driving off and in deep snow conditions. • Reduction in steering effort thanks to the tandem 4 wheels. • Vibrations are reduced due to the alignment of the wheels with the rolling band of the track and the shaft damper mounted tandem. • Better steering precision because of this wheel and track alignment due to good ground contact. • 1.25" (3.175 cm) lugs in the front and in the back for better traction and lateral stability. • Track width: front 12.5" and rear 15". • Adds 3" (7.62 cm) of ground clearance versus 27" tires. 	<ul style="list-style-type: none"> • Additional shaft dampers, tandem dampers, track design and wheel layout significantly reduce NVH (noise vibration harshness). • Central guide for optimized track alignment and reduced occurrences of detracking. • Optimized track layout with increased angle of attack for better obstacle crossing and snow performances. • Stamped and welded steel frame for improved strength and durability. • Easy maintenance with replaceable hub and wheel bearings. • Main hub is oil bath with 3 bearings inside for consistent lubrication. • DPS module and engine and CVT pre-filter required. • Mounting kit sold separately. 	

Cennik zawiera sugerowane ceny detaliczne brutto w walucie PLN. Ceny mogą ulec zmianie bez wcześniejszego uprzedzenia.
Installation of some accessories shown may impact vehicle compliance with some regulations. Consult your local dealer for information.
 Cennik nie jest ofertą w rozumieniu prawa.

NEW Apache XC Track System

G3, G3L (2023 & up)

28 929,00 zł

715008664



- Brand-new track design to optimize driving off and in deep snow conditions.
- Reduction in steering effort thanks to the tandem 4 wheels.
- Vibrations are reduced due to the alignment of the wheels with the rolling band of the track and the shaft damper mounted tandem.
- Better steering precision because of this wheel and track alignment due to good ground contact.
- 1.25" (3.175 cm) lugs in the front and in the back for better traction and lateral stability.
- Track width: front 12.5" and rear 15".
- Adds 3.25" of ground clearance vs 25" tires.
- Additional shaft dampers, tandem dampers, track design and wheel layout significantly reduce NVH (noise vibration harshness).
- Central guide for optimized track alignment and reduced occurrences of detracking.
- Optimized track layout with increased angle of attack for better obstacle crossing and snow performances.
- Stamped and welded steel frame for improved strength and durability.
- Easy maintenance with replaceable hub and wheel bearings.
- Main hub is oil bath with 3 bearings inside for consistent lubrication.
- DPS module and engine and CVT pre-filter required.
- Mounting kit sold separately.

Installation of some accessories shown may impact vehicle compliance with some regulations. Consult your local dealer for information.

Apache 360 & 360 LT

NEW Apache XC & XC LT Mounting Kit

(Not illustrated)

G3, G3L (2023 & up)

1 829,00 zł

715008264

- Required for installation of the Apache XC and XC LT Track System.
- Track DPS Module and Pre-Filter not included.

Installation of some accessories shown may impact vehicle compliance with some regulations. Consult your local dealer for information.

Apache 360 Track System

G3L

27 627,00 zł

715006323



- Multifunctional tracks perfect for any Can-Am ATV.
- Average ground clearance of 16" (41 cm).
- 1" (2.5 cm) lugs in the front and 1.25" (3.2 cm) in the back.
- Apache 360 and 360 LT Mounting Kit and engine and air intake pre-filters are required.
- EC compliant.

Installation of some accessories shown may impact vehicle compliance with some regulations. Consult your local dealer for information.

Apache 360 LT Track System

G3L

34 040,00 zł

715005103



- Multifunctional tracks designed to support heavy loads and to fit on most Can-Am Off-Road vehicles.
- Front wheel height adjustment provides enhanced attack angle and better performance over rough terrain when raised or increased contact patch for improved flotation when lowered.
- Average ground clearance of 16" (41 cm).
- 1" (2.5 cm) lugs in the front and 1.25" (3.2 cm) in the back.
- Reliable heavy-duty build.
- EC compliant.
- Contact patch is 7 to 9% bigger than the Apache 360's.
- Apache 360 and 360 LT Mounting Kit, Track DPS Module and Engine and air intake pre-filters are required.

Installation of some accessories shown may impact vehicle compliance with some regulations. Consult your local dealer for information.

Apache 360 & 360 LT Mounting Kit

(Not illustrated)

G3L

2 055,00 zł

715004992

- Required to install Apache 360 and 360 LT Track Systems.
- DPS module and pre-filter not included.
- Improved installation time and switch seasons faster than ever.
-

Installation of some accessories shown may impact vehicle compliance with some regulations. Consult your local dealer for information.

Apache Track System Accessories

Track DPS Module

(Not illustrated)

G3, G3L (without iTC)

442,00 zł

715007338

G3, G3L (with iTC)

442,00 zł

715006266

- An innovative DPS module that ensures speedometer accuracy and optimized steering assist, which make for perfect track control and riding ease.
- Required to install the Apache and Backcountry Track Systems.
-

Installation of some accessories shown may impact vehicle compliance with some regulations. Consult your local dealer for information.

—Cennik zawiera sugerowane ceny detaliczne brutto w walucie PLN. Ceny mogą ulec zmianie bez wcześniejszego uprzedzenia.

Cennik nie jest ofertą w rozumieniu prawa.

NEW Air Intake Engine Pre-filter | G3, G3L | 196,00 zł | **715008314**



- Adds extra protection for your engine in harsh riding conditions.
- The filter blocks particles larger than 0.005".
- Necessary when tracks are installed.

Idler Wheel Kit | Apache Backcountry Track System (rear tracks only) | 267,00 zł | **860201230** · 141 mm



- Reduces drag and rolling resistance.
- Includes 2 wheels, brackets and hardware.
- Add up to 2 kits per rear track.
- Can extend slider life in hardened snow conditions.

Sliders with Vespel⁺ Inserts | Apache Backcountry Track System | 636,00 zł | **503194815**



- Use DuPont Vespel inserts for less friction.
- Longer life.
- Can be cut to desired length.
- 8 needed per vehicle.
- Sold individually.

Rail Ice Scratchers | Apache Backcountry Track System | 590,00 zł | **860201728**



- Provide additional lubrication in hard and icy conditions.
- Rail mounted, small, light.
- Design expands on coil concept to allow reversing without damage.
- Easily stored when not in use.

APACHE TRACK SYSTEMS FITTING GUIDE

Apache Backcountry

Model Year / Model	Track	Track Mount	Track DPS Module	Engine Pre-filter	CVT Pre-filter
2023 & Up	G3L	715005247	715004993	715008314	Not required
	G3				

Apache XC and XC LT

Model Year / Model	Track	Track Mount	Track DPS Module	Engine Pre-filter	CVT Pre-filter
2023 & Up	G3L	715008264	715008264	715008314	Not required
	G3				

Apache 360 and Apache 360 LT

Model Year / Model	Track	Track Mount	Track DPS Module	Engine Pre-filter	CVT Pre-filter
2023	G3L	715004992	715004992	715008314	Not required

Cennik zawiera sugerowane ceny detaliczne brutto w walucie PLN. Ceny mogą ulec zmianie bez wcześniejszego uprzedzenia.
Cennik nie jest ofertą w rozumieniu prawa.

PROMOUNT PLOWS

PROMOUNT PLOW KITS

Steel – Reference Chart

	54" Black Steel	54" Yellow Steel	60" Black Steel	60" Yellow Steel	66" Black Steel	66" Yellow Steel	72" Black Steel	72" Yellow Steel
Plow Kit	715006202	715006206	715006203	715006207	715006205	715006208	—	—
Blade	715004472	715005316	715004202	715005317	715006337	715006338	715004474	715006021
Push Frame	715004980	715004980	715004980	715004980	715004980	715004980	715004980	715004980
Mounting Kit	715009483	715009483	715009483	715009483	715009483	715009483	715009483	715009483

Flex2 – Reference Chart

	60" Flex2	66" Flex2	72" Flex2
Plow Kit	715006204	715008206	—
Blade	715004203	715006265	715004485
Push Frame	715004980	715004980	715004980
Mounting Plate	715009483	715009483	715009483

Steel Plows

Can-Am ProMount 54" (137 cm) Steel Plow Kit

G3L

■ 715006202 · Black
■ 715006206 · Yellow



This kit includes:

- Can-Am ProMount Steel Blade
- Push Frame with Quick-Attach System
- Mounting Kit
- Plow Roller Fairlead

Can-Am ProMount 60" (152 cm) Steel Plow Kit

G3L

■ 715006203 · Black
■ 715006207 · Yellow



This kit includes:

- Can-Am ProMount Steel Blade
- Push Frame with Quick-Attach System
- Mounting Kit
- Plow Roller Fairlead

Can-Am ProMount 66" (168 cm) Steel Plow Kit

G3L

■ 715006205 · Black
■ 715006208 · Yellow



This kit includes:

- Can-Am ProMount Steel Blade
- Push Frame with Quick-Attach System
- Mounting Kit
- Plow Roller Fairlead

Cennik zawiera sugerowane ceny detaliczne brutto w walucie PLN. Ceny mogą ulec zmianie bez wcześniejszego uprzedzenia.
Cennik nie jest ofertą w rozumieniu prawa.

Can-Am ProMount Steel Blades 54" (137 cm) Blade	Fits ProMount Push Frame	<ul style="list-style-type: none"> ■ 715004472 · Black ■ 715005316 · Yellow 	<p>1 644,00 zł</p> <p>1 509,00 zł</p>
--	--------------------------	---	---------------------------------------



- Blades available individually to create your own kit.
- Compatible with Can-Am ProMount Blade accessories to further enhance plow versatility (some plow accessories are not compatible with 54" (137 cm) plows).
- Not compatible with ProMount Drift Cutters, Blade Extensions and Edge Markers.
- Clears 50" (127 cm) when plow is fully angled.
- Blade height of 14.75" (37 cm).

Can-Am ProMount Steel Blades 60" (152 cm) Blade	Fits ProMount Push Frame	<ul style="list-style-type: none"> ■ 715004202 · Black ■ 715005317 · Yellow 	<p>1 779,00 zł</p> <p>1 644,00 zł</p>
--	--------------------------	---	---------------------------------------



- Blades available individually to create your own kit.
- Compatible with Can-Am ProMount Blade accessories to further enhance plow versatility.
- Clears 54" (137 cm) when plow is fully angled.
- Blade height of 17" (43 cm).

Can-Am ProMount Steel Blades 66" (168 cm) Blade	Fits ProMount Push Frame	<ul style="list-style-type: none"> ■ 715006337 · Black 	<p>2 285,00 zł</p>
--	--------------------------	--	--------------------



- Blades available individually to create your own kit.
- Compatible with Can-Am ProMount Blade accessories to further enhance plow versatility.
- Clears 60" (152 cm) when plow is fully angled.
- Blade height of 17" (43 cm).

Can-Am ProMount Steel Blades 72" (183 cm) Blade	Fits ProMount Push Frame	<ul style="list-style-type: none"> ■ 715004474 · Black ■ 715006021 · Yellow 	<p>2 601,00 zł</p> <p>2 190,00 zł</p>
--	--------------------------	---	---------------------------------------



- Blades available individually to create your own kit.
- Compatible with Can-Am ProMount Blade accessories to further enhance plow versatility.
- Clears 66" (168 cm) when plow is fully angled.
- Blade height of 17" (43 cm).

Can-Am ProMount Flex2 Plow Kit

Can-Am ProMount 60" (152 cm) Flex2 Plow Kit	G3L	<ul style="list-style-type: none"> ■ 715006204 · Black 	
--	-----	--	--



- This kit includes:
- Can-Am ProMount Flex2 Blade
 - Push Frame with Quick-Attach System
 - Mounting Kit
 - Plow Roller Fairlead

Can-Am ProMount 66" (168 cm) Flex2 Plow Kit	G3L	<ul style="list-style-type: none"> ■ 715008206 · Black 	
--	-----	--	--



- This kit includes:
- Can-Am ProMount Flex2 Blade
 - Push Frame with Quick-Attach System
 - Mounting Kit
 - Plow Roller Fairlead

Can-Am ProMount Flex2 Plows

Can-Am ProMount Flex2 60" (152 cm) Blade	Fits ProMount Push Frame	715004203	2 235,00 zł
---	--------------------------	------------------	-------------



- Plow blade made of UHMWPE, flexible and impact absorbing material prevents damaging your plow when accidental impacts occur.
- Replaceable wear blade.
- Large pin designed for easy blade rotation to eliminate snow buildup at pivot point.
- Blade design provides best snow roll-off at any angle.
- Compatible with Can-Am ProMount Blade accessories to further enhance plow versatility.
- Clears 54" (137 cm) when plow is fully angled.
- Blade height of 17" (43 cm).

Can-Am ProMount Flex2 66" (168 cm) Blade	Fits ProMount Push Frame	715006265	2 556,00 zł
---	--------------------------	------------------	-------------



- Plow blade made of UHMWPE, flexible and impact absorbing material prevents damaging your plow when accidental impact occurs.
- Replaceable wear blade.
- Large pin designed for easy blade rotation to eliminate snow buildup at pivot point.
- Blade design provides best snow roll-off at any angle.
- Clears 60" (152 cm) when plow is fully angled.
- Blade height of 17" (43 cm).
- Compatible with Can-Am ProMount Blade accessories to further enhance plow versatility.

Can-Am ProMount Flex2 72" (183 cm) Blade	Fits ProMount Push Frame	715004485	2 922,00 zł
---	--------------------------	------------------	-------------



- Plow blade made of UHMWPE, flexible and impact absorbing material prevents damaging your plow when accidental impacts occur.
- Replaceable wear blade.
- Large pin designed for easy blade rotation to eliminate snow buildup at pivot point.
- Blade design provides best snow roll-off at any angle.
- Compatible with Can-Am ProMount Blade accessories to further enhance plow versatility.
- Clears 66" (168 cm) when plow is fully angled.
- Blade height of 17" (43 cm).

Angle Plows

Can-Am ProMount Angle Blades 60" (152 cm) Steel Oneway State Blade	G3, G3L	715007261	2 375,00 zł
---	---------	------------------	-------------



- Make the job easier with the right tools, clear long alleys and make the task easier by sending the snow further out of the way.
- Wing end of plow measures 25" (63 cm) high and tapers down to 17" (43 cm).
- One-way "winged" state plow designed to throw snow higher.
- Rubber Flap (715007299) designed to keep snow away from the driver is offered as accessory (sold separately).
- Can-Am branded.

Can-Am ProMount Angle Blades 66" (168 cm) Steel Oneway State Blade	G3, G3L	715007263	2 831,00 zł
---	---------	------------------	-------------



- Make the job easier with the right tools, clear long alleys and make the task easier by sending the snow further out of the way.
- Wing end of plow measures 25" (63 cm) high and tapers down to 17" (43 cm).
- One-way "winged" state plow designed to throw snow higher.
- Rubber Flap (715007299) designed to keep snow away from the driver is offered as accessory (sold separately).
- Can-Am branded.

Can-Am ProMount Angle Blades 72" (183 cm) Steel Oneway State Blade	G3, G3L	715007264	3 012,00 zł
---	---------	------------------	-------------



- Make the job easier with the right tools, clear long alleys and make the task easier by sending the snow further out of the way.
- Wing end of plow measures 26" (67 cm) high and tapers down to 17" (43 cm).
- One-way "winged" state plow designed to throw snow higher.
- Rubber Flap (715007299) designed to keep snow away from the driver is offered as accessory (sold separately).
- Can-Am branded.

ProMount One-Way State Blade Rubber Flap <i>(Not illustrated)</i>	715007299	552,00 zł
---	------------------	-----------

- Allows for more efficient snow projections in various snow conditions.









Can-Am ProMount Plow Accessories

Can-Am ProMount Push Frame with Quick-Attach System	G3, G3L	715004980	2 285,00 zł
--	---------	------------------	-------------

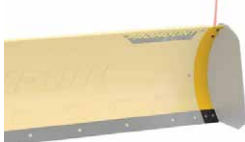

- Heavy-duty steel tubes designed to withstand the roughest use.
- Mount location provides the ultimate push strength and traction.
- Designed for maximum plow lift height.
- Features a self-aligning quick-attach system, an easy foot-release pedal and an ergonomic handle for plow angle adjustment.
- Allows blade to swivel left or right in five positions.
- Compatible with all Can-Am ProMount blades.
- Plow Roller Fairlead and Plow Limit Switch recommended to extend winch cable lifespan.
- Can-Am ProMount Mounting Kit required for installation.

Cennik zawiera sugerowane ceny detaliczne brutto w walucie PLN. Ceny mogą ulec zmianie bez wcześniejszego uprzedzenia.
Cennik nie jest ofertą w rozumieniu prawa.

Can-Am ProMount Push Frame Extension	G3, G3L	715006257	802,00 zł
	<ul style="list-style-type: none"> • 12" (30 cm) push frame extension. • Required when plow is installed with Apache Track System. 		
Can-Am ProMount Mounting Kit	G3, G3L	715009483	552,00 zł
	<ul style="list-style-type: none"> • Required to install the Can-Am ProMount Push Frame with Quick-Attach System. • 20 mm mounting rods are designed to stay in place all year round without compromising on ground clearance. • No drilling required. • Quick installation directly to the chassis. • Plow Roller Fairlead included. 		
Can-Am ProMount Edge Markers	G3, G3L	715004206	209,00 zł
	<ul style="list-style-type: none"> • Help locate the edges of your plow. • Height: 24" (60 cm). • Sold in pairs. • Compatible with Can-Am ProMount Steel and Flex2 Blades with or without Blade Extensions (except for the Can-Am ProMount Steel 54" (137 cm) Blades). 		
Can-Am ProMount Drift Cutters	G3, G3L	715006258	732,00 zł
	<ul style="list-style-type: none"> • Help keep snow in the plow. • Dimensions: 17" x 13" (43.2 cm x 33 cm). • Sold in pairs. • Compatible with Can-Am ProMount Steel and Flex2 Blades with or without Blade Extensions (except for the Can-Am ProMount Steel 54" (137 cm) Blades). 		
Can-Am ProMount Plastic Wear Blade	G3, G3L	715004480 · 54" (137 cm) 741,00 zł 715004481 · 60" (152 cm) 845,00 zł 715004482 · 66" (168 cm) 949,00 zł	
	<ul style="list-style-type: none"> • To help prevent scratches on smooth driveways and markable surfaces. 		
Can-Am ProMount Curved Wear Blade	G3, G3L	715007791 · 60" (152 cm) 608,00 zł 715007792 · 66" (168 cm) 608,00 zł 715007793 · 72" (183 cm) 608,00 zł	
	<ul style="list-style-type: none"> • Wear blade designed with a folded back bottom lip. • The increased surface allows for less digging while plowing uneven surfaces. • Ideal for snow covered gravel, grass, paver stone and other soft surfaces. 		
Can-Am ProMount Plow Blade Extensions	G3, G3L	■ 715004205 · Black 636,00 zł ■ 715005319 · Yellow 636,00 zł	
	<ul style="list-style-type: none"> • Add 3" (8 cm) each side. • Compatible with Can-Am ProMount Blades (except for Can-Am ProMount Steel 54" (137 cm) Blade). • Longer Wear Blade can be installed to further extend the extra length already provided by the extensions. • Compatible with Can-Am ProMount Steel and Flex2 Blades (except for the Can-Am ProMount Steel 54" (137 cm) Blades). 		
Back Drag Blade	ProMount Plows (60" and more)	715007794	1 475,00 zł
	<ul style="list-style-type: none"> • ¼" thick steel swivel scraper. • Lifts up when the vehicle is moving forward so as not to affect the scraping. • Increased capacity to pull snow. • More aggressive scraping in reverse mode. • Lifts the blade off the ground so that it scrapes evenly. • Adjustable in length for compatibility with 60", 66" and 72" blades. • Compatible with ProMount blades (Flex and Steel). 		

Cennik zawiera sugerowane ceny detaliczne brutto w walucie PLN. Ceny mogą ulec zmianie bez wcześniejszego uprzedzenia.
Cennik nie jest ofertą w rozumieniu prawa.

Plow Roller Fairlead	G3L	705009222	339,00 zł
-----------------------------	-----	------------------	-----------



- Larger diameter lower roller reduces wear on wire rope for plow application.
- Can be used with all ProMount plows.
- Included in the Can-Am ProMount Mounting Kit (715009483).

Pulley Kit for Alpine Super-Duty Plow	G3, G3L	715000279	305,00 zł
--	---------	------------------	-----------



- Pulley kit to be used in conjunction with the winch when using a snow plow.
- Recommended to increase winch efficiency.
- To be used with the XT Front Bumper.

Plow Limit Switch <i>(Not illustrated)</i>	G3, G3L	715006319	660,00 zł
--	---------	------------------	-----------

- To control the cable tension when raising your plow system.
- Prevents winch, plow push frame and vehicle damage.

Can-Am ProMount Plow Angling System	G3, G3L	715009657	2 742,00 zł
--	---------	------------------	-------------



- Converts your plow system into an easy-to-control unit from the driver's seat.
- Using one hand to control all plow motions will allow you to easily concentrate and manage your plowing tasks.
- Compatible with ProMount Blade.
- Push Frame (715007752) is required.
- Push Frame Extension (715006257) is required for installation with the Front Rancher Bumper.
- Winch and plow sold separately.

Cennik zawiera sugerowane ceny detaliczne brutto w walucie PLN. Ceny mogą ulec zmianie bez wcześniejszego uprzedzenia.
Cennik nie jest ofertą w rozumieniu prawa.



PARTS AND MAINTENANCE

Keep an Eye on These Parts	86
XPS Tires	88
XPS Oil & Oil Change Kits	89
Maintenance Products	90



CAN-AM TOUGH

Trust genuine Can-Am parts to keep your vehicle performing at its best.

ONE-YEAR WARRANTY*

Precisely engineered. Rigorously tested. Factory approved.

*Covers parts and labor when fitted at an authorized dealer.

Cennik zawiera sugerowane ceny detaliczne brutto w walucie PLN. Ceny mogą ulec zmianie bez wcześniejszego uprzedzenia.
Cennik nie jest ofertą w rozumieniu prawa.

CAN-AM ATVs G2, G2L, G2S



To make sure your ATV performs as you expect,
keep an eye on these components:**

OIL FILTER 420256188

ENGINE OIL*

4T 10W-50 Synthetic Oil	
1 quart / 946 ml	9779234
1 US gallon / 3.785 L	9779235

4T 0W-40 Synthetic Oil	
1 quart / 946 ml	9779139
1 US gallon / 3.785 L	9779140

4T 5W-40 Synthetic Oil	
1 quart / 946 ml	9779492
1 US gallon / 3.785 L	9779493

OIL CHANGE KIT*

5W-40 Synthetic Oil	
500 cc or more V-twin engine	9779488

0W-40 Synthetic Oil	
500 cc or more V-twin engine	9779259

10W-50 Synthetic Oil	
500 cc or more V-twin engine	9779252

5W-40 Full Synthetic	
450cc or less	9779487

0W-40 Synthetic Oil	
450cc or less	9779257

EMISSION CONTROL

Fuel tank vent breather filter (Non-EVAP models)	709001120
--	-----------

Canister vent pre-filter (CARB and EVAP models)	709001109
---	-----------

ENGINE AIR FILTER

Performance Air Filter by Twin Air†	
Premium Air Filter	715001333
Premium Air Filter	707800371

CVT AIR FILTER

G2S	707001786
G2, G2L	715003483

DRIVE BELT

450 cc & less Premium (Stock)	422280283
---	-----------

500 cc & more Premium (Stock)	422280360
---	-----------

BRAKE PADS

Metallic G2 Front & Rear Left	715900248
Front & Rear Right	715900249

Organic G2, G2L, G2S (except X mr models)	
Front & Rear Left	715601015
Front & Rear Right	715601014

CV BOOT KITS

G2, G2L, G2S (except X mr models)	
Front Wheel Side	705401345
Front Differential Side	705401346
Rear	705501864

X mr models	
Front Wheel Side	705401354
Front Differential Side	705401355
Rear	705501864

WHEEL BEARINGS	293350150
-----------------------	-----------

A-ARM BUSHING KIT	703500875
--------------------------	-----------

BALL JOINTS

Upper	706202044
--------------	-----------

Lower	706202045
--------------	-----------

SPARK PLUG

450, 850, 1000R engines	715900352
--------------------------------	-----------

570, 650, 1000 engines	715900642
-------------------------------	-----------

BATTERY

G2S, G2, G2L 18 Amps. Wet (YTX20 L-BS)	296000444
--	-----------

DS (250, 90, 70, 50) 13 Amps. Wet (YTX16 L-BS)	V31500MAA020
---	--------------

* For Europe, please check the correspondent PNs on page 89.

**Refer to periodic maintenance chart for proper intervals.

Cennik zawiera sugerowane ceny detaliczne brutto w walucie PLN. Ceny mogą ulec zmianie bez wcześniejszego uprzedzenia.

Cennik nie jest ofertą w rozumieniu prawa.

CAN-AM ATVs G3, G3L



To make sure your ATV performs as you expect,
keep an eye on these components:**

ENGINE OIL*

4T 10W-50 Synthetic Oil

1 quart / 946 ml 9779234
1 US gallon / 3.785 L 9779235

4T 0W-40 Synthetic Oil

1 quart / 946 ml 9779139
1 US gallon / 3.785 L 9779140

4T 5W-40 Synthetic Oil

1 quart / 946 ml 9779492
1 US gallon / 3.785 L 9779493

OIL CHANGE KITS*

5W-40 Full Synthetic 9779480
HD7 ace 650cc single
cylinder

0W-40 Synthetic Oil 9779481
HD7 ace 650cc single
cylinder

OIL FILTER 420256188

Oil Filter Cover O-Ring 420230922

Drain Plug Sealing Ring 420552280

EMISSION CONTROL

Fuel tank vent breather 709001120
filter
(Non-EVAP models)

Canister vent pre-filter 709001109
(CARB and EVAP models)

ENGINE AIR FILTER

G3 703501249

G3L 703501247

DRIVE BELT

Belt for 700/HD7
G3 850cc and 1000cc &
G3L 700cc 420280225

Belt for 500/HD5
G3L 500cc 420280226

METALLIC BRAKE PADS

Left/Right brake pad kit* 705602167
(4 pads per kit/hardware
included)

*Fits front/rear on G3
and front on G3L.

Rear brake pad kit** 705602168
(2 pads per kit/hardware
included)

**Fits rear on G3L

CV BOOT KITS

Front CV Outer Boot Kit
G3-G3L 715500456

Front CV Inner Boot Kit
G3-G3L 715500457

Rear CV Outer Boot Kit
G3-G3L 715500464

Rear CV Inner Boot Kit
G3-G3L 715500465

WHEEL BEARING 293350150

BALL JOINTS

Ball Joints Lower 706202045

Ball Joints Upper 706202044

SPARK PLUG 715900785

BATTERY

G3 715900973

G3L 296000444

* For Europe, please check the correspondent PNs on page 89.

**Refer to periodic maintenance chart for proper intervals.

Cennik zawiera sugerowane ceny detaliczne brutto w walucie PLN. Ceny mogą ulec zmianie bez wcześniejszego uprzedzenia.

Cennik nie jest ofertą w rozumieniu prawa.

XPS TIRES

SHOP BY USAGE



GRAVEL &
HARD PACK



ROCK



MUD

XPS Trail Force



- All-terrain radial tire.
- 8-ply rated construction.
- Versatile and suitable for many types of terrain.
- Aggressive tread pattern for better traction on dirt, mud and rocky terrains.
- Tread depth: 20 mm (0.78").

705403026 · 26X8R14
705503322 · 26X10R14
705402754 · 27X9R14
705503103 · 27X11R14

XPS Trail King



- All-terrain radial tire.
- 8-ply rated construction.
- Aggressive tread pattern for tougher terrains.
- An almost continuous center tread offers a smoother trail ride.
- Tread depth: 26 mm (1.02").

705402713 · 26X8R12*
705503073 · 26X10R12*
705403081 · 27X9R14

705503355 · 27X11R14
705402825 · 28X9R14
705503181 · 28X11R14

*6 ply rating

XPS Trail King 2



- All-terrain radial tire.
- 6-ply rated construction.
- Tire excels in various terrains from loose to hard packed.
- Non directional tread pattern with optimized construction providing precision handling ensuring maximum grip and low rolling resistance
- Tread depth: 20 mm (0.78").

705403398 · 26X8R14
705503518 · 26X10R14
705403397 · 27X8R14
705503517 · 27X10R14

XPS Trac Force



- All-terrain light truck style radial tire.
- 8-ply rated construction.
- Central tread for good grip and comfort on compact terrain.
- Tread depth: 18 mm (0.71").

705403080 · 30X9R14
705403369 · 30X9R15
705503354 · 30X10R14
705403586 · 30X10R14 UT*

705403370 · 30X10R15
705403416 · 32X10R16 UT*
705403587 · 32X10R15 UT*
*6 ply rating

XPS Hammer Force



- Light truck-inspired tire.
- 8-ply rated construction.
- Rock-crawling tread pattern with unique contact patch.
- Aggressive sidewall for maximum traction when faced with technical terrains.
- Tread depth: 15 mm (0.59").

705402918 · 30X10R15

XPS Swamp Force



- Hybrid radial tire for mud and trail.
- 8-ply rated construction.
- Unique tread pattern allowing good grip in mud and mud ejection.
- Center tread provides for comfortable trail riding.
- Tread depth: 36-38 mm (1.41"-1.49").

705403201 · 30X9R14
705503387 · 30X11R14

XPS Swamp King



- Bias tires for mud and trail.
- 6-ply rated construction.
- Ultimate performance in mud without sacrificing good trail handling.
- Tread depth: 38 mm (1.49").

705403028 · 28X8X14
705503324 · 28X10X14

XPS Swamp King XL



- Bias ply for mud and trail
- 6-ply rated construction.
- Our best performing mud tire that does not compromise your trail riding
- Deep V grooved Lugs with extended shoulder tread for max traction in deep ruts that also help eject mud faster.
- Tread depth: 38 mm (1.49") center, max depth 52 mm (2.05").

705503687 · 30X9X14
705403381 · 30X10X14

Cennik zawiera sugerowane ceny detaliczne brutto w walucie PLN. Ceny mogą ulec zmianie bez wcześniejszego uprzedzenia.
Cennik nie jest ofertą w rozumieniu prawa.

LUBRICANT & OIL CHANGE KIT

Lubricant

XPS 4T 10W-50 Synthetic Oil

9779234 (US) · 1 qt / 946 ml
9779240 (EU) · 1 qt / 946 ml

9779235 · 1 US gal / 3.785 L



- Engineered for heavy-duty and high-performance 4-stroke engines, including turbocharged, supercharged and racing engines.
- Formulated using carefully selected and strenuously tested base stocks and custom additives.
- Offers thick film strength to protect bearings, and a proven high-temp detergency to minimize deposits, prevent shear, provide thermal stability, and combat fuel dilution to ensure maximum performance from your engine.

XPS 4T 0W-40 Synthetic Oil

9779139 (US) · 1 qt / 946 ml
9779286 (EU) · 1 qt / 946 ml

9779140 (US) · 1 US gal / 3.785 L
9779287 (EU) · 1 US gal / 3.785 L



- Powersport formula with premium anti-wear and anti-corrosion additives.
- The best choice for high-performance snowmobile, ATV and SXS 4-stroke engines used in cold weather.
- Provides superior engine and transmission protection against heat, rust and corrosion.
- Delivers optimal performance in high and low temperatures.

XPS 4T 5W-40 Synthetic Blend Oil

9779133 (US) · 1 qt / 946 ml
9779290 (EU) · 1 qt / 946 ml

9779134 (US) · 1 US gal / 3.785 L
9779291 (EU) · 1 US gal / 3.785 L



- Off-road formula with premium anti-wear and anti-corrosion additives.
- Designed for high-performance off-road, on-road and PWC 4-stroke engines, including turbo or supercharged powersports engines.
- Provides superior engine and transmission protection against rust and corrosion, even in extreme conditions.

Oil Change Kit

Engine Oil Change Kit

Models



- Ultra-convenient "all-in-one" Engine Oil Change Kit saves time and money.
- Includes XPS Synthetic or Synthetic Blend Oil, oil filter, O-rings and washer.

5W-40 Synthetic Blend Oil / 450 cc or less	9779256 (US) 9779408 (EU)
0W-40 Synthetic Oil / 450 cc or less	9779257 (US) 9779409 (EU)
5W-40 Synthetic Blend Oil / 500 cc or more V-twin engine	9779258 (US) 9779405 (EU)
0W-40 Synthetic Oil / 500 cc or more V-twin engine	9779259 (US) 9779406 (EU)
10W-50 Synthetic Oil / 500 cc or more V-twin engine	9779252 (US) 9779401 (EU)
0W-40 Synthetic Oil / 650 ACE	9779481 (US) 9779417 (EU)
5W-40 Synthetic Oil / 650 ACE	9779480 (US) 9779416 (EU)
5W-40 Synthetic Blend Oil / 900 ACE	9779260 (US) 9779410 (EU)
10W-50 Synthetic Oil / 900 ACE	9779261 (US) 9779411 (EU)

Cennik zawiera sugerowane ceny detaliczne brutto w walucie PLN. Ceny mogą ulec zmianie bez wcześniejszego uprzedzenia.
Cennik nie jest ofertą w rozumieniu prawa.

MAINTENANCE PRODUCTS

Synthetic Gear Oil

75W-90
75W-140

9779158 (US) · 1 qt / 946 ml
9779212 (Europe) · 1 qt / 946 ml
9779160 (US) · 1 qt / 946 ml
9779215 (Europe) · 1 qt / 946 ml



- Uses custom additives to provide the best performance in Visco-Lok™ and Smart-Lok™ differentials.
- Allows higher loads, superior shear stability and reduced oxidation.
- Exceptional wear protection and superior performance at all operating temperatures.

Extended Life Pre-Mixed Coolant

9779150 · 1 qt / 946 ml
619590728 (Scandinavia) · 1 qt / 946 ml



- Antifreeze/coolant contains the correct dilution and the necessary additives to prevent corrosion and inhibit cavitation in BRP cooling systems.
- Long-life, 5-year formula specially formulated for BRP vehicles.
- Superior heat transfer.
- Ideal replacement for vehicles that normally use a 2-year antifreeze/coolant (green).
- 5 years (orange).

Anti-Corrosive Lubricant

9779701 · 120 oz / 340 g
619590733 (Scandinavia) · 120 oz / 340 g



- Multipurpose lubricant that can also be used to prevent rust, corrosion and moisture intrusion.
- It contains extreme pressure additives that work as an all-around lubricant for just about anywhere lubrication is needed.

Extreme Duty Suspension Grease

(Not Illustrated)

9779708 · 14 oz / 400 g

- Designed to work specifically with the components found in Can-Am vehicle suspensions.
- It is highly stable and offers optimal lubrication at both extreme cold and high temperatures while protecting suspension components from dirt and moisture, as well as corrosion under extreme washout conditions.

XPS Spline Grease

(Not illustrated)

9779704 (US) · 4 oz / 115 g
9779472 (Europe) · 4 oz / 115 g

- Enhanced rust and corrosion resistance.
- Protects against seizure, heat-freeze, galling, rust and corrosion.

DOT 4 Brake Fluid

9779151 (US) · 12 fl. oz. / 355 ml
9779207 (Europe) · 12 fl. oz. / 355 ml



- Meets or exceeds all DOT3 and DOT4 brake fluid requirements.
- High-temperature formula resists fade and also conditions seals and O-rings in braking system.

Racing Brake Fluid RS600

9779171 (US) · 12 fl. oz. / 355 ml
9779183 (Europe) · 12 fl. oz. / 355 ml



- Exceeds DOT4 brake fluid requirements for extreme conditions and competition use.
- Extreme, 579-degree boiling point temperature is ideal for high-demand competition conditions to combat brake fade.
- Will not harm seals or braking system components.
- Should be added only to a clean/unfilled system to avoid dilution and diminished performance.
- Low-moisture formula slows water vapor absorption through multiple heat cycles.
- Recommended for use in Ski-Doo and Can-Am racing applications.

Fuel Stabilizer

9779171 (US) · 8 fl oz / 236 ml
9779183 (Europe) · 8 fl oz / 236 ml



- Ethanol-compatible and will stabilize fuel in your tank to keep it from breaking down and causing hard starting, throttle hesitation and poor run quality.
- Since ethanol attracts moisture, this product contains powerful anti-corrosion additives to protect fuel system components.
- Prevents problems associated with E10 fuels.

Cennik zawiera sugerowane ceny detaliczne brutto w walucie PLN. Ceny mogą ulec zmianie bez wcześniejszego uprzedzenia.

Cennik nie jest ofertą w rozumieniu prawa.

Quady Śrem - tel. 61 28 35 657 - email: biuro@sklepatv.pl - www.sklepatv.pl



BRP REIMAGINES THE WAY YOU ACCESS YOUR WORLD

Can-Am is one of many success stories from BRP, the global company behind some of the most daringly innovative products and experiences that move you.

Because it's not about the destination, it's about the journey — yours.

Discover our brands:

ski-doo **LYNX** **SEA-DOO** **can-am** **ROTAX** **ALUMACraft** **MANITOU** **QUINTREX**

www.brp.com



Cennik zawiera sugerowane ceny detaliczne brutto w walucie PLN. Ceny mogą ulec zmianie bez wcześniejszego uprzedzenia.
Cennik nie jest ofertą w rozumieniu prawa.

